

LIGHT MEASUREMENT SOLUTIONS



Table of contents

Spectrometers	4
GL Optic	4
GL SPECTIS 1.0	6
GL SPECTIS 1.0 Touch	9
GL SPECTIS 1.0 Touch + Flicker	12
GL SPECTIS 4.0 M	15
GL SPECTIS 5.0 Touch	17
Goniometers	19
GL Optic	19
GL GONIO SPECTROMETER GLG 8-850	21
GL GONIO SPECTROMETER GLG 30-1800	23
GL GONIO PHOTOMETER GLG A 50-1800	24
Light Meters	26
GL Optic	26
GL OPTICAM 4.0 M SC	29
GL OPTICAM 3.0 4K TEC	32
GL OPTICAM 2.0 4K TEC	37
GL OPTICAM 1.0	42
GL PHOTOMETERS	46
GL RETROREFLECTOMETER 4.0 SRS	51
GL SPECTROLUX	54
LUMINANCE / RADIANCE	57
ILLUMINANCE / IRRADIANCE	61
GL Opticam 1.0	64
GL OPTI PROBES for radiometric measurements - GL Optic	65
GL OPTI PROBES for photometric measurements - GL Optic	67
Integrating Spheres	69
GL Optic	69
GL LARGE OPTI SPHERES	71
GL OPTI SPHERE 1100	74
GL OPTI SPHERE 500	77
GL OPTI SPHERE 205	80
GL OPTI SPHERE 48	83
GL OPTI LIGHT LED	86
GL Opti Sphere 1100 - GL Optic	89
GL Opti Sphere 48 - GL Optic	90
Calibration Services	91
GL Optic	91
GL TEC CONTROL SYSTEM	93
GL Opti Light LED - GL Optic	95

Software	97
GL Optic	97
GL EPREL PRODUCT REGISTRATION SPECTROSOFT ADD-ON	99
GL AUTOMATION - SPECTROSOFT ADD-ON	102
GL SPECTROSOFT M	105
GL Spectrosoft Automation - GL Optic	108
GL Spectrosoft - GL Optic	109

SPECTROMETERS





Partner **GL Optic**



GL Optic is a Polish-German manufacturer specializing in advanced light measurement systems for photonics and precision optics applications. Their comprehensive portfolio includes spectroradiometers, photometers, integrating spheres, goniometers, and luminance cameras, all designed to deliver accurate and reliable measurements across a broad spectrum of light sources.

Product offering

GL SPECTIS 1.0



GL SPECTIS 1.0 Touch



GL SPECTIS 1.0 Touch + Flicker



GL SPECTIS 4.0 M



GL SPECTIS 5.0 Touch



← [Back to partner](#)



Light Measurement Solutions > Spectrometers

GL SPECTIS 1.0

This high-quality and easy to operate device gives you all you need for reliable light measurement. Implementing this practical instrument in your development and production environments can help you improve the light quality of your product and accelerate development.



Don't let the small size fool you. GL SPECTIS 1.0 handheld spectroradiometer can measure any light source and provide the results you need. Evaluate products meet spec before you buy, develop better products faster, or ensure your products are manufactured properly. GL SPECTIS 1.0 can be configured to do it all.

Depending on your application you can use this handheld spectroradiometer as an illuminance / irradiance meter when you connect it to your PC, you can plug it to a small integrating sphere for single LEDs color and lumen measurements or combine it with a larger integrating sphere for the testing of luminous flux and efficacy of LEDs. Luminance testing is also possible with the use of dedicated additional PROBES.

With its coded and interchangeable measurement head, GL SPECTIS 1.0 can be combined with optical probes, integrating spheres or goniometers to measure any type of light sources, displays as well as LED lights. Thanks to its high sensitivity and accuracy, it is the perfect solution for light measurement.



This handheld spectroradiometer is calibrated to provide absolute values of illuminance and color but also provides detailed spectral power distribution and irradiance values [mW/m²]. Use this on optical bench or tripod to create a measurement setup connected to PC.



Available luminance optical probes can be connected and calibrated with this handheld spectroradiometer to measure flat emitting surfaces like displays, screens and back lights. The integrated coding system in all spectrometers automatically downloads the appropriate calibration file and measures [cd/m²].



Connect this handheld spectroradiometer with our GL OPTI SPHERE 48 to measure luminous flux (lumen) and color of single LEDs. This is ideal for incoming QC and evaluation of LEDs, drivers and other components during development.



Pair this universal light measurement spectrometer with our small GLG 8-850 goniometer or the large GLG 30-1800 system for accurate LED lighting measurements and get photometric files and colorimetric data at once.

Key features:

- high sensitivity and precise calibration
- low noise and stable measurements
- ready to work when connected to PC (after about 10 min)
- small size and low energy consumption
- powered via USB connection

Applications include final lamp assessment and testing of complete lighting installations. The GL SPECTIS 1.0 is an excellent choice for common LED measurement applications.

For more information, simply complete the [contact form](#), and a member of our team will be in touch shortly.

[← Back to partner](#)



Light Measurement Solutions > Spectrometers

GL SPECTIS 1.0 Touch

GL SPECTIS 1.0 Touch portable spectrometer offers unmatched performance and flexibility. With an interchangeable detector, the system can be used for wide range of applications and measurement geometries. Use in the field, the lab or both!

This intuitively-operated instrument is ideal for lamp and luminaire manufacturers, installers and lighting auditors who want to control and improve the quality of LED lighting products. From incoming component testing, through the research and development up to the final product testing and verification.



GL SPECTIS 1.0 Touch was designed based on the experience gained from our original non-touchscreen model, the GL SPECTIS 1.0. The goal was to create a spectral LED light meter for customers who wanted to have a simple solution without any sacrifice in optical performance and dependability.

This battery-operated standalone device is ideal for different light measurement applications – from the laboratory to field testing. Through extensive engineering in the design and calibration procedures, this device provides the highest accuracy of any handheld spectral light measurement device. We understand that light measurement is not an easy task, but thanks to the GL SPECTIS 1.0 Touch, you no longer need to be an expert to make professional LED lamps evaluation.

Measure any light source and get the results you need. Evaluate products meet spec before you buy, develop products faster, or ensure your products are manufactured properly. GL SPECTIS 1.0 Touch can do it all.

Keep up on the latest industry requirements and metrics with our lifetime upgrades. From standard quantities like spectrum, lux and CCT to new requirements like TM-30, PAR/PPFD and EML.

GL SPECTIS 1.0 Touch spectral meter is unlike any other handheld on the market. With a range of interchangeable accessories your SPECTIS can grow with your business from standard illuminance [lx] measurement to luminous flux [lm], and luminance [cd/m²] measurement.

More than just a handheld device, it can be combined with other accessories for a wide range of applications:



Simple way to turn your illuminance spectrometer into a single LED tester to measure luminous flux, color CRI, and TM30 rendering properties. Install the GL OPTI SPHERE 48 directly on the device for quick and precise LED testing.



Measure any flat light emitting surface with GL SPECTIS 1.0 Touch and optional GL OPTI PROBE 1.0 for luminance and radiance. Connect via fiber optic on tripod or directly on the LED/OLED surface.



For aquarium or underwater LED lighting, use our LED light meter with optional water-tight probe for evaluation of submarine, aquarium, or other underwater installations.



For horticulture or agriculture lighting, evaluate effective irradiance values (PAR, PPFD, etc.) using our spectral light and PAR meter, with advanced analysis via GL SPECTROSOFT M.

Key features:

- Completely portable device
- Color LCD Touch screen
- Communication features: USB cable, SDcard slot
- Android based operating system
- Up to 4 hours on battery

Applications include quality control and improvement of LED lighting products, incoming component testing, research and development of lamps and luminaires, final product testing and verification, and field or laboratory measurements for lighting audits.

For more information, simply complete the [contact form](#), and a member of our team will be in touch shortly.

← [Back to partner](#)



Light Measurement Solutions > Spectrometers

GL SPECTIS 1.0 Touch + Flicker

An upgraded version of the very successful GL SPECTIS 1.0 Touch spectral light meter. This variant takes portable light measurement to a new level. This innovative light spectrometer instrument can now measure flicker of light in addition to the extensive range of standard photometric and colorimetric values available on the GL SPECTIS 1.0 Touch for color and intensity all within seconds.



GL SPECTIS 1.0 Touch light flicker meter is now equipped with additional electronics and fast photodiode to measure flicker frequency, flicker index and flicker ratio. Designed and developed in consultation with industry leaders and standards committees, this device provides all the measurement quantities required to accurately measure and understand flicker.

Stay ahead of the competition by incorporating flicker measurements in your suite of optical testing. While still only an emerging requirement in many areas, characterizing flicker will soon become the norm. New metrics like SVM and California Title 24, we have it covered! Read more about flicker measurements and new requirements on GL blog.

Why use multiple measurement devices to characterize your light when it can all be captured with a single portable light spectrometer. Less devices to carry, and less reports to combine. Get it all with the push of a button. Use it to collect spectral and flicker data in the lab or field. Need additional analysis or reporting capabilities? Use our optional GL SPECTROSOFT M.

GL SPECTIS 1.0 Touch light flicker meter offers a great standalone solution, but can also be paired with a range of accessories. From integrating spheres to goniometers, in the lab or the field, this system has you covered. Configure the system to measure illuminance, flicker metrics or luminous flux and even luminance of LEDs using an optional optical probe.

When the first “flicker-free” football stadium lighting was installed at Chelsea Arena in the UK, GL Optic was asked to provide a device which could be used as an auditing tool to check the newly installed lighting. The contractor needed to evaluate the photometric and colorimetric values including illumination [lx], color temperature (CCT), color rendering properties of LED (CRI), television index (TI) and additionally verify if it was a flicker-free installation.

This project triggered the development of the GL SPECTIS 1.0 Touch + Flicker, improving on our existing GL SPECTIS 1.0 Touch by integrating an additional electronic circuit board with the fast photodiode to capture the optical flicker characteristics. The result is possibly the best handheld flicker spectroradiometer on the market. Covering an exceptional wide range of frequencies with accuracy equal to some laboratory devices.

GL Optic takes an active part in a Philips (currently Signify) Working Group which is focused on establishing new flicker metric standards throughout the industry. Thanks to this direct cooperation we have an opportunity to compare and evaluate our accuracy daily using the reference standard provided by Philips.

We are also able to include the latest flicker metrics like flicker index, flicker percent and flicker frequency together with the latest SVM (Stroboscopic Visibility Measure) – a new standard to assess how the lighting installation might influence human visibility performance.

GL SPECTIS 1.0 Touch + Flicker meter is an intuitively operated touchscreen portable light spectrometer, equally suited to the lab as it is in the field. With a range of software analysis capabilities and extensive suite of accessories, this device is in a category all its own.

More than just a handheld device, it can be combined with accessories for a wide range of applications:



Measure lighting installations to check illumination [lx], CCT, CRI, TM 30-15 flicker index, flicker percent, SVM for visual effects, and circadian metrics like EML and S/P ratio.



Use GL SPECTIS 1.0 Touch + Flicker light spectrometer to measure very high frequencies up to 12 kHz for broadcasting and studio lighting evaluation. Includes CCT, CRI, and TLCI indices verification.



Connect with GL OPTI SPHERE 48 to measure flux and color of single LEDs. Supports binning verification and quality control during development and incoming QC of LEDs, drivers, and other components.



Available luminance optical probes can be connected and calibrated to measure flat emitting surfaces like displays, screens, and backlights. The spectrometer automatically downloads calibration files and measures [cd/m²].

Key features:

- Compact, portable, solidly built
- Intuitive, color LCD touch screen user interface
- Laboratory Grade accuracy and repeatability
- Dark current and temperature compensation
- Automatic accessory detection and calibration loading
- Use standalone, or in conjunction with system accessories

Applications include quality control and improvement of LED lighting products, incoming component testing, research and development of lamps and luminaires, final product testing and verification, and field or laboratory measurements for lighting audits.

For more information, simply complete the [contact form](#), and a member of our team will be in touch shortly.

[← Back to partner](#)



Light Measurement Solutions > Spectrometers

GL SPECTIS 4.0 M

High-precision modular spectroradiometer with CCD Back-Thinned cooled (or thermally stabilized) sensor is delivering high resolution and increased sensitivity. Based on the customizable design and available accessories it can be used for variety of applications, both in laboratory and industrial settings.



The primary goal in designing the new spectroradiometer was to develop a new modular technology for optical radiation measurements. The idea was to design an instrument which could be tailored to customers individual needs and still maintain laboratory grade accuracy.

Thermal stabilization applied directly to the detector reduces noise and the values of dark current, which directly improves the measurement capabilities of low-level signals, especially in the ultraviolet range (e.g. LED UV-C). The solution will also ensure independence from the ambient temperature in the application range.

The variable optical path module ensures flexibility in adjustment of the optical properties of the system to the nature of the measured signal by changing the aperture and filters. This solution allows the user to quickly adapt the instrument to particular measurement needs, often eliminating the need to install a dedicated measuring probe for each application. All while maintaining calibration parameters for all optical path configurations.

GL SPECTIS 4.0 M high-end spectroradiometer features the latest optical solutions for precise light quality control in a variety of applications. For demanding measurement applications in the laboratory or production environment, it is equipped with Peltier module, which reduces measurement uncertainty due to lower signal noise and minimized dark current levels.

With its universal modular design, GL SPECTIS 4.0 M is a perfect choice to easily build a dedicated measuring instrument. By adding an extra filter it is possible to extend spectral range for specific needs. When connected to an integrating sphere, the measurement of total luminous flux and radiant power is possible. When combined with luminance / radiance telescopic probes, specialized evaluation of optical radiation related hazards and light quality can be performed.

We value proper calibration procedures and smart system design. Each spectroradiometer is individually calibrated and before the Absolute Spectral Calibration process, various pre-calibration stages are performed, such as wavelength calibration, non-linearity correction, and stray-light examination.

Key Features:

- Spectral range from 200 nm to 1050 nm
- Measurement uncertainties of only ± 0.0015 for standard chromaticity coordinates

- Integration times from 10 ms to 60 s
- Measurements illuminance levels of 1 lx feasible
- Dynamic range of the device is increased towards lower signal levels
- Cooled back-thinned detector to minimize dark current & noise levels
- Variable optical path for specific applications
- Shutter - for automatic dark current compensation
- Additional probes with quick connector and automatic detection
- Ethernet connection
- Dedicated GL AUTOMATION 4.0 M software for spectral analysis
- Optional filters on demand
- Rack housing available
- Increasing the dynamic range can be increased towards higher signal levels using advanced filters

Applications include laboratory and industrial measurements, daily quality control of LED production, UV and photobiological safety assessment and development of new designs of lighting fixtures.

For more information, simply complete the [contact form](#), and a member of our team will be in touch shortly.

[← Back to partner](#)



Light Measurement Solutions > Spectrometers

GL SPECTIS 5.0 Touch

With the GL SPECTIS 5.0 Touch optical spectrometer, the accuracy and configurability of portable light measurement devices has been taken to a new level. Until now, photometric and radiometric accuracy this high was only available in high end lab systems. Using this state-of-the-art spectral light measurement instrument, you can get lab grade data anywhere you go. Our light spectrometers are individually calibrated to deliver precise results quickly, with options to include our industry leading GL SPECTROSOFT M for advanced analysis and reporting.



This truly unique LED spectrometer can be configured to cover an extended spectral range from UV to NIR using a single sensor, calibrated for absolute measurements from 200 nm to 1050 nm. The practical design of this instrument allows for various types of measurements for a range of different applications. From UV measurements in Photobiological Safety tests through lab accuracy VIS range LED lamps evaluation to IR range tests of LEDs in medical application. GL SPECTIS 5.0 optical spectrometer has you covered.

GL SPECTIS 5.0 Touch optical light meter features a large laboratory grade back thinned CCD sensor from Hamamatsu delivering extraordinary stability over longer exposure times. The device is calibrated with the use of reference standards which are traceable to national laboratories and confirmed by the globally recognized factory calibration. Electronic dark current levels are monitored automatically with intelligent compensation for any drift due to temperature fluctuations.

GL SPECTIS 5.0 portable spectroradiometer uses the latest photonics technology to provide an easy-to-use, precise and practical tool for lighting professionals. When you have a demanding measurement applications outside laboratory, or you need immediate dependable results, this fully self-contained optical spectrometer is the ideal solution. Connect to a PC for use in the lab, production or other industrial location where light or any other optical radiation must be measured.

With the universal concept and design of the GL SPECTIS 5.0 Touch, you can easily expand your measurement system by adding any one of our integrating spheres or additional accessories. Measure irradiance with standard diffusor or fiber optic probes. Connect to spheres for flux measurement or combine this instrument with luminance / radiance telescope for specialized evaluation of hazards and quality.

The idea to create an extended spectral range, high performance in a portable spectroradiometer was raised many times during contact with customers using our other handheld spectrometers for LED testing. Many users of our laboratory instrumentation were also asking if it would be possible to have the same accuracy in a smaller device so that you don't have to carry bulky laboratory devices into the field.

This was the origin of the GL SPECTIS 5.0 Touch light spectrometer which was designed by merging the practical self-contained features of our GL SPECTIS 1.0 series with the top end accuracy optical system coming from a typical laboratory instrument. The result is one of the premier solutions in the market for advanced LED and optical radiation measurements for general lighting, medical, electronic and scientific applications.

Key Features:

- extended spectral range from 200 to 1050nm
- very high resolution: 2.5nm optical and 0.5nm data point
- OSR system for Stray Light Reduction
- touch screen display
- photometric and radiometric calibration
- Dark Current Compensation
- Micro SD
- variety of integrating spheres and probes available
- automatic accessory detection
- laboratory accuracy

Applications include advanced LED and optical radiation measurements for general lighting, medical, electronic, and scientific purposes, as well as specialized laboratory-grade measurements of light sources and optical components.

For more information, simply complete the [contact form](#), and a member of our team will be in touch shortly.

GONIOMETERS





Partner **GL Optic**



GL Optic is a Polish-German manufacturer specializing in advanced light measurement systems for photonics and precision optics applications. Their comprehensive portfolio includes spectroradiometers, photometers, integrating spheres, goniometers, and luminance cameras, all designed to deliver accurate and reliable measurements across a broad spectrum of light sources.

Product offering

**GL GONIO
SPECTROMETER GLG
8-850**



The image shows a compact, black spectrometer with a red, semi-circular goniometer arm mounted on a black base. The base has the GL Optic logo and model number.

**GL GONIO
SPECTROMETER GLG
30-1800**



The image shows a larger spectrometer with a red goniometer arm and a green circular component. It has a black base with a horizontal orange arrow indicating a sliding mechanism. The base also features the GL Optic logo and model number.

**GL GONIO
PHOTOMETER GLG A
50-1800**



The image shows a photometer system consisting of a black base unit, a vertical column, and a separate control panel with a screen and buttons. A small sample holder is attached to the side of the base unit.



Light Measurement Solutions > Goniometers

GL GONIO SPECTROMETER GLG 8-850

This easy-to-operate system combines the functionality of a goniophotometer with the features of a spectroradiometer to measure flux and to check angle dependent luminous intensity together with the colorimetric data required by international standards. The upgraded GLG 8-850 version is a table top light goniometer specifically designed for LED modules and component testing.



The GLG 8-850 goniometer is a top-of-the-range benchtop goniometer designed to measure LED modules and smaller luminaires and to test components. The automated system allows to measurement of devices weighing up to 8 kg and with a diameter of 850 mm. The system with computer and GL Spectrosoft add-on software, enables measurements with an angular resolution of 0.1° and in the angular range of the C axis and $\lambda \pm 180^\circ$.

Don't let the size fool you. GLG 8-850 offers the ability to measure not only LED modules or small luminaires, but also vehicle lamps, thanks to the optional Type A conversion kit. The included lasers allow precise positioning of the DUT on the goniometer and measurement of the distance to the measuring instrument. In addition, the goniometer can be equipped with a temperature stabilization module.

GL Optic's devices are constantly updated to work in accordance with worldwide standards. Compliance with CIE S025/E:2015 and IES LM-79 ensure, that the results obtained can be used to sell products worldwide.

There is no need to build a large laboratory. The compact size of the GLG 8-850 goniometer, the intuitive interface software and the best price/performance ratio is a great basis for starting your own measurements. Instead of ordering measurements from external laboratories and wait for results, now you can have them done in minutes!

Key Advantages:

- Simple interface to perform advanced tests and measurements.
- Build-to-last mechanical system with integrated aluminium base including controllers and connectors with plug-and-measure concept. Ideal for LED modules and linear lights.
- Programmable turnkey system with smooth and quick operation. Optional sliders for optimum photometric distance settings are available.
- Included laser alignment tool allows for quick positioning and distance measurements.
- Connectors for peripheral power supply in the base are wired with banana sockets placed close to DUT

Applications include photometric and colorimetric characterization of LED modules and small luminaires, measurement of light intensity distribution and luminous flux, testing of lighting components, measurement of car lamps, projectors, and signal lamps used in land transport and aviation, generation of IES/LDT photometric files, compliance testing with international standards, in-house R&D and quality control, and laboratory or test-station evaluation of compact lighting products.

For more information, simply complete the [contact form](#), and a member of our team will be in touch shortly.

← [Back to partner](#)



Light Measurement Solutions > Goniometers

GL GONIO SPECTROMETER GLG 30-1800

GL GONIO SPECTROMETER GLG 30-1800 combines the functionality of a goniophotometer with the features of a spectroradiometer to measure brightness and to check angle dependence luminous intensity distribution. With easy to use software, precise alignment protocols and extensive automation capabilities, the system offers a new level of performance and usability.



The GLG 30-1800 gonio spectrometer removes the dependency on highly skilled technicians to deliver reliable results. With easy to use software, precise alignment protocols and extensive automation capabilities, the system offers a new level of performance and usability.

While this goniospectrophotometer generates spectral and color data at any angle, it remains true to its primary use - generating IES/LDT output files, simply and with the click of a button.

With an extended max load up to 30 kg and 1800 mm diameter max dimension, the GL GONIO SPECTROMETER GLG 30-1800 will cover most of the demand for testing. Have a range of small and large fixtures? No problem. The system can accurately characterize big and small fixtures without any mechanical changes.

Key Advantages:

- Manual controller supports the user to align the lamp position before measurements. An easy to use software interface shortens configuration time and allows for quick DUT description and settings.
- Robust CNC machined body of the device is durable and stable enough to hold large lamps and guarantees long lasting performance. Exceptional lamp size capacity 1800 mm x 700 mm.
- Tried and tested industrial gears paired with high accuracy absolute encoders to provide best angular accuracy and repeatability.
- Unique laser alignment system with mirrors and system control options helps to calibrate system vertical and horizontal alignment and also faster photometric positioning of DUT.
- Smart cable management system will help keep the cables neat and turning connectors will help avoid problems with tangled cables during tests and faster connections. Banana connectors right next to the DUT provide the necessary electric power stability.

Applications include the measurement of car lamps, projectors, and signal lamps used in land transport and aviation, as well as angular-dependent photometric and spectral characterization of LED luminaires, measurement of luminous intensity distribution, generation of IES/LDT files, in-house R&D and quality control testing, verification of lighting specifications for designers, and laboratory testing of small to large lighting fixtures.

For more information, simply complete the [contact form](#), and a member of our team will be in touch shortly.



GL GONIO PHOTOMETER GLG A 50-1800

GL GONIO PHOTOMETER GLG A 50-1800 has been designed in accordance with CIE 121-1996 and IESNA LM-75-01 standards governing photometric and colorimetric far-field measurement systems. It allows the determination of photometric characteristics in H, V coordinates for automotive lamps and headlights as well as all kinds of signaling equipment used, for example, in aviation. This goniometer system can support samples of up to 50 kg weight and 1800 mm width.



The GLG A 50-1800 goniophotometer is built with the highest quality mechatronic components from leading manufacturers. This ensures high accuracy of the entire system and repeatability of movements. The design of the goniophotometer allows the measurements of lamps weighing up to 50 kg and measuring up to 1800 mm length (optional up to 2600 mm).

GL Optic's equipment is constantly updated to work in accordance with internationally available standards. The GLG A 50-1800 goniophotometer works in accordance with CIE 121-1996 and IESNA LM-75-01 standards, and the system enables photometric testing in accordance with UN/ECE instructions and FMVSS requirements based on SAE standards.

The goniophotometric system working with the GL PHOTOMETER 3.0 LS + Flicker reduces measurement time by up to 5 times! The high sampling rate together with the high sensitivity of the sensor allows continuous On-fly measurement during smooth lamp movement. Using the flicker measurement function, it is possible to determine the light modulation characteristics.

The GL Optic goniophotometer is characterized by its high precision, robust design and user-friendly interface. In cooperation with a photometer, spectrometer and retroreflectometer, it forms a complete system for the automotive industry.

Key Features:

- Far Field Type A goniometer
- H, V axes rotation and X, Y, Z linear movement with servo motors
- Angular resolution of 0.002°
- Universal DUT mounting table adjustable in three axes
- 10 inch LCD touch screen and manual controller
- Compatible with photometer, spectroradiometer, colorimeter and retroreflectometer
- Reduced weight for easier transport and installation
- Designed for safety and convenience of operation

Applications include photometric and colorimetric far-field measurements of automotive exterior lamps and headlights, signaling equipment for land transport and aviation, in-house R&D and quality control testing, compliance testing according to international standards, flicker and light modulation analysis of indicators and emergency lights, and laboratory-grade testing of large luminaires and lighting systems.

For more information, simply complete the [contact form](#), and a member of our team will be in touch shortly.

LIGHT METERS











Partner **GL Optic**

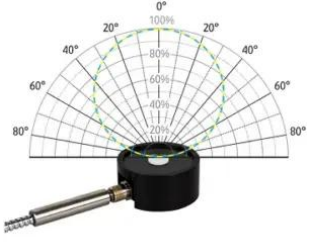
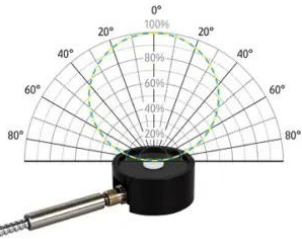

GL Optic is a Polish-German manufacturer specializing in advanced light measurement systems for photonics and precision optics applications. Their comprehensive portfolio includes spectroradiometers, photometers, integrating spheres, goniometers, and luminance cameras, all designed to deliver accurate and reliable measurements across a broad spectrum of light sources.

Product offering

<p>GL OPTICAM 4.0 M SC</p> 	<p>GL OPTICAM 3.0 4K TEC</p> 	<p>GL OPTICAM 2.0 4K TEC</p> 	<p>GL OPTICAM 1.0</p> 
<p>GL PHOTOMETERS</p> 	<p>GL RETROREFLECTOMETE R 4.0 SRS</p> 	<p>GL SPECTROLUX</p> 	<p>LUMINANCE / RADIANCE</p> 
<p>ILLUMINANCE / IRRADIANCE</p> 	<p>GL Opticam 1.0</p> 	<p>GL OPTI PROBES for radiometric measurements - GL Optic</p>	<p>GL OPTI PROBES for photometric measurements - GL Optic</p>



[← Back to partner](#)



Light Measurement Solutions › Light Meters

GL OPTICAM 4.0 M SC

A revolution in luminance and color measurements

A novel luminance and color distribution measurement tool available on the market is the GL OPTICAM 4.0 M SC image luminance camera. The combination of image luminance and color measurement with measurements from an integrated spectroradiometer covering the ultraviolet to near-infrared regions is a new development in the industry. The GL OPTICAM 4.0 M SC is not your typical image luminance camera because it consists of two independent devices housed in one container. Spectral power distribution measurements provide a wealth of additional information about the thing being studied.

Matrix spectral sensitivity correction

Matrix spectral sensitivity adjustment is used by GL OPTICAM 4.0 M SC to enable accurate colorimetric data capture. Modular technology has made it possible to obtain spectral distribution and radiance data in the chosen regions of interest while accounting for the proper spectral efficiency. The device may be used with ease and dependability thanks to dedicated GL OPTICAM SOFT M image processing software, which also facilitates fast processing and evaluation of the data obtained by the imaging luminance and color meter. A report that can be customized can be created based on the analysis results. The new software makes it possible to create a smooth workflow, which significantly streamlines the otherwise difficult measuring and analysis procedure.



Automatic lens detection

For quick measurements of brightness and color distribution in both lab and production settings, this camera system is already set up. When installed lenses are detected by the device, it instantly chooses the correct calibration file. With our plug-and-measure imaging luminance camera for LEDs and other light sources, you can now quickly and accurately examine the luminance distribution of your light sources.

Sequential measurement

Higher signal levels are guaranteed by a special sequential measurement technique compared to methods that make use of simple optical filters or beam splitters.

Additional features of the GL OPTICAM 4.0 M SC, such as an integrated depolarizer, encourage a greater dynamic range and guarantee that the system is prepared to handle the difficulties involved in measuring displays.

Simplify production testing

A stable luminance testing solution is necessary for the optical performance of instrument clusters, backlit buttons, and displays. It is necessary for developers, designers, and quality engineers to confirm light leakage, brightness distribution, contrasts, and homogeneity. This innovative optical tool makes it simple and accurate to verify all touch-screen control panels, backlit buttons, displays, keyboards, and telltale lights in R&D and production.



GL OPTICAM 4.0 M SC Usage

Imaging Luminance & Color Meter

High-resolution and high-sensitivity measurements of brightness and color distribution parameters are possible with the GL OPTICAM 4.0 M SC. GL Optic's newest equipment allows for fast verification of an individual element's uniformity of brightness, chromatic coordinates, and CCT.

Evaluation and characterization of displays

Manufacturers of displays and individual components must test their goods at different phases of the manufacturing process. With its integrated spectroradiometer and image luminance camera, the new GL OPTICAM 4.0 M SC is a comprehensive solution that enables accurate luminance and color distribution measurement in a matter of seconds. It is an ideal tool for many industries, particularly the automotive, aviation, and display production sectors, but it can also be used for quality control in general illumination.

When color matters

Using a luminance camera and a separate colorimeter is no longer necessary. When various color LEDs are used in a lighting fixture or electrical board, the GL Optic breakthrough color camera can effortlessly deliver complete colorimetric and spectral data with great precision.

GL OPTICAM 4.0 M SC Features

Blue light hazard measurements

The spectral measurement of the backlighting, the blue light hazard weighted function, and the corrected luminance measurements enable BLH assessment for each point of the tested object based on the LB value.

Precise measuring of x,y coordinates next to L for each pixel

A sensitivity adjustment is applied to each pixel of the image based on spectral measurements of the backlighting sources. This yields an accurate reading of color coordinates at each location on the measured display.

GL OPTICAM 4.0 M SC Metrics

Using the GL OPTICAM 4.0 M SC, you can measure all of the following quantities:

Photometric quantities

- Point luminance [cd/m²]
- Luminance distribution, contrast
- Isocandela diagram
- Average, mean luminance
- Min Max diagram and tables

Colorimetric quantities

- Correlated Color Temperature - CCT and Duv
- Color Rendering Indices - CRI, R1 to R14
- TM-30 - Rf, Rg, CVG
- Color uniformity
- Binning and color consistency
- Spectral power distribution

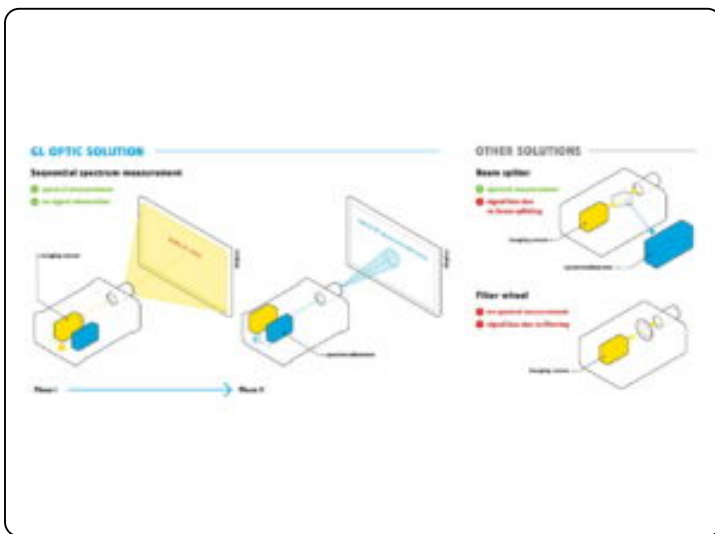



GL OPTICAM 3.0 4K TEC

First fully adapted system for road lighting measurements according to the EN 13201: 2016 standard

Prior to the release of GL OPTICAM 3.0 4K TEC, measuring luminance distribution required a lot of individuals with specialized skills to participate in a laborious, expensive, and time-consuming process. The complete measurement data required to quickly determine the brightness distribution of the chosen road and area lighting standard compliance is provided by the new image luminance measuring technology. The GL OPTICAM 3.0 4K TEC is the world's first solution that is completely suited for field measurements, in contrast to previous laboratory meters.

It has a thermal stabilization unit (TEC) to correct for measurement inaccuracies caused by temperature variations in the image sensor. With its hermetic housing (IP 54), you can work in the field and be ready for any weather situation without worrying about damaging your camera. It also features a battery-operated power source, which eliminates the need for portable power supplies and power generators for outside operations. Determining the measuring field and finishing the measurement procedure are made simple by the set of accessories that are offered.



Street and area lighting verified

It is quick and easy to measure airport illumination, tunnel lighting, pedestrian crossing zones, and street luminance. This high sensitivity and high resolution camera system is ready to go for instantaneous measurements of the brightness distribution in any field setting. With our top-notch image luminance measuring gadget, you may plug it in and measure whenever you need a trustworthy portable brightness test.

Road lighting compliance to EN 13201

The analysis program is user-friendly and displays the results instantly, along with whether the installation complies or does not comply with the presumptions and specifications for the road lighting class as specified by EN 13201. Additionally, the software offers a feature that no other system on the market has up to this point: the ability to generate a report at the push of a button.

Adapted for field work

With the protection of hermetic housing (IP 54), thermal stabilization, a sturdy tripod, and accessories, you can operate in any weather without worrying about damaging your camera. To keep you covered when working outside, it has features including a measuring wheel, transportation cases, measurement field

markings, and a battery power supply.



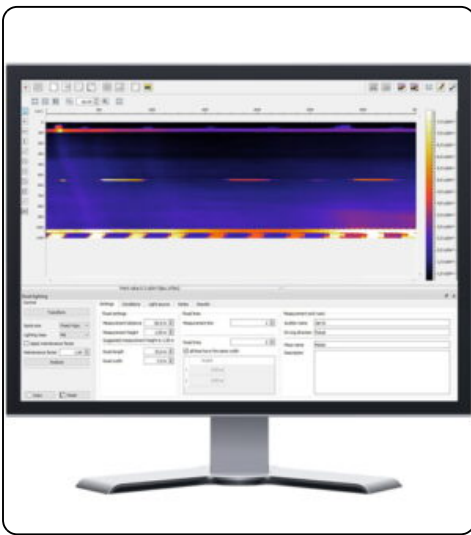

GL OPTICAM 3.0 4K TEC Usage

Smart development programme

Working with Poznan University of Technology, the GL OPTICAM imaging luminance equipment was developed and implemented under the National Center for Research and Development Program. The project's objective was to commercialize a measurement device that facilitates on-site assessments of luminance distribution. Though there are a lot of luminance meters on the market, all of them are made for laboratory use and aren't really intended for measuring road luminance.

Using both spot luminance meters and an imaging luminance measuring device, the staff of the Poznań

University of Technology's Department of Light Technology and Electrothermal Energy has many years of expertise measuring brightness on highways. An objective evaluation of the road lighting installation performance is made possible by the use of an ILM D meter, which greatly simplifies measurement procedures and contributes to the acquisition of more trustworthy data.

Focusing on road lighting quality

Road brightness measurement is a difficult task. This system is ready to take measurements on the road at the location. The hermetic casing of the camera is designed to prevent mechanical damage to the lens and system. The supplied power pack and auxiliary devices enable professional field measurement, and the thermally stabilized sensor is prepared to operate in a variety of temperatures. It can be applied in many settings while preserving the precision and efficiency of the laboratory.

Measuring system that works outdoors

The system also comes with a reflective safety vest, a measuring wheel for distance measurement, a heavy-duty elevating tripod, an extra battery pack, and specially made measurement field markers. This is all assembled into travel-ready cases to form a transportable measuring stand.

Adding colorimetry

Our GL SPECTIS 1.0 Touch spectroradiometer and this luminance meter can be used together to perform colorimetric testing and evaluation. Combining the spectroradiometric measurement with the luminance camera measurements is possible with our GL SPECTROSOFT. This allows us to provide complete colorimetric and spectral data for the LED product that is being tested, as well as mismatch correction for brightness values to obtain the best accuracy.

GL OPTICAM 3.0 4K TEC Features

Plug and measure

Digital luminance camera system that is individually calibrated and preconfigured for instantaneous luminance distribution assessment. Measuring the absolute brightness level is as simple as placing this device on the tripod in front of the lighting system. The device is applicable in both laboratory and field settings.

Dedicated V- lambda filter

A carefully chosen class A optically adjusted filter is fitted to every camera to ensure the best possible brightness measurements that match the sensitivity of the human eye. Every filter has a unique optimization for every CMOS sensor.

Thermal stabilisation

Temperature variations in the image sensor are compensated for by the TEC-controlled image sensor temperature.

Adding spectrum and color

The quality control can be expanded with colorimetric values such as CCT, CRI, and many more by combining this new picture luminance camera with our spectrum instruments, such as GL SPECTIS 1.0 Touch. It will also enable the measurements of multiple-color LED devices and offer an automatic filter mismatch adjustment process.

GL OPTICAM 3.0 4K TEC Metrics

Photometric quantities

- Point Luminance [cd/m²]
- Luminance distribution
- Iso candela diagram
- Average luminance
- Min Max diagram and tables

Spectral color quantities*

- Correlated Color Temperature – CCT and Duv
- Color Rendering Indices – Ra, CRI, R1 to R14
- New rendering Rf and TM-30
- Color Uniformity
- Binning and color consistency
- Spectral Power Distribution

← [Back to partner](#)



Light Measurement Solutions › Light Meters

GL OPTICAM 2.0 4K TEC

Laboratory imaging luminance cameras for a variety of applications

Faster changes in the design and complexity of backlit components in the automotive, transportation, electronics, and other industries are posing challenges for optical engineers and system developers. The employment of contemporary LED and OLED components to improve user interfaces presents development teams and QA/QC staff with a problem when it comes to quality verification. For optical examinations and measurements, they are all in need of dependable and easily available devices.

The GL OPTICAM 2.0 4K TEC is an imaging luminance measuring tool that was created to help the quicker adoption of contemporary LED and OLED lighting systems by confirming compliance and evaluating the functionality of lighting components. A stable luminance testing solution is necessary for the optical performance of instrument clusters, backlit buttons, and displays. It is necessary for developers, designers, and quality engineers to confirm light leakage, brightness distribution, contrasts, and homogeneity. Throughout the R&D and manufacturing phases, all touch-screen control panels, backlit buttons, displays, keyboards, and indicator lights may be quickly and accurately tested with this innovative optical device.

The high-resolution, laboratory-performance optical camera system GL OPTICAM 2.0 4K TEC has a dedicated V-Lambda correction filter that perfectly adjusts the system's sensitivity (response) to a human's eye sensitivity. It also features a high-resolution 9M pixel CMOS image sensor. Depending on the exact needs for brightness measurement, this optical system comes with a variety of top-notch lenses. The technology includes a patent-pending RFID lens recognition system and an image sensor with thermal stabilization to compensate for measurement mistakes caused by temperature changes.

This spectroradiometer can be used in conjunction with 00GL SPECTIS 1.0 Touch to test color.



RFID automatic lens recognition

With a large laboratory-grade back-thinned CCD sensor from Hamamatsu, the GL SPECTIS 4.0 optical light

meter offers exceptional stability over extended exposure times. The gadget is calibrated using globally recognized factory calibration and reference standards traceable to National Laboratories. Automatic monitoring of electronic dark current levels is combined with intelligent drift adjustment for temperature variations.

Improved optical resolution

Select the appropriate parts to improve the performance of your product. In the R&D department, utilizing a brightness measuring camera system directly will enhance quality control while saving costs and time. This accurate brightness measuring device with a 9-pixel resolution can enhance your research and development when creating a new, intricate optical system. You can now decide on modification and/or compliance more quickly.

Thermally stabilized sensor

Our novel, fast, and accurate imaging technology for brightness measurements and tests is perfect for manufacturing quality control and backlit module development. This image luminance meter provides accurate and useful data for pass-fail production monitoring systems. It can be utilized in the lab or integrated into production online and offline testers for LED modules, displays, and instrument cluster testing.

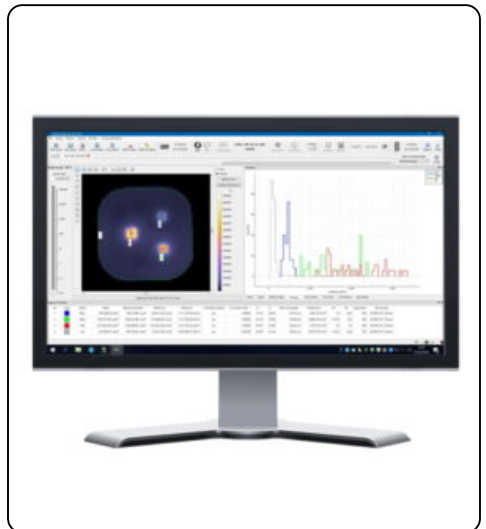
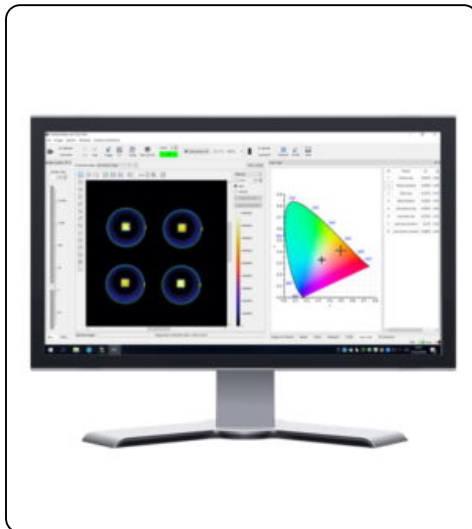
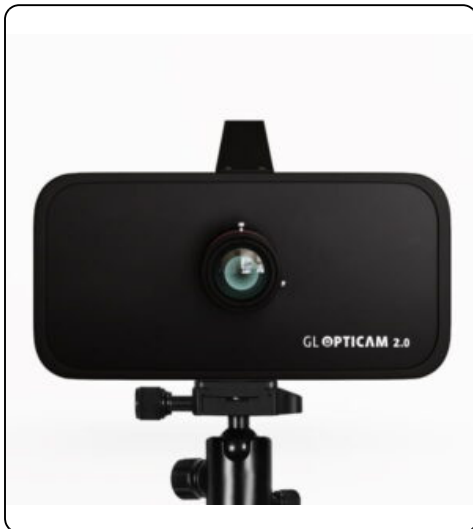

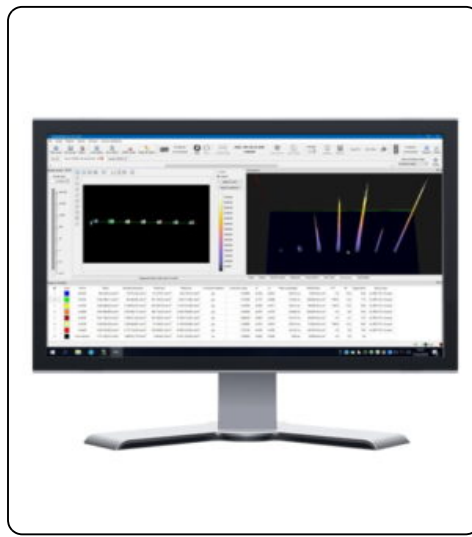
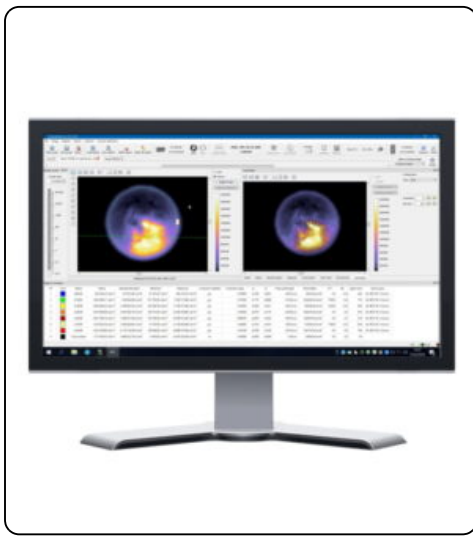

GL OPTICAM 2.0 4K TEC Usage

Drive your critical requirements with specialized instrument

The new GL OPTICAM Imaging Luminance Measuring Device (ILMD) was developed primarily for the automobile and home appliance electronics industries. Precise testing of lighting components is even more important because of the growing number of touch panels and intricate instrument clusters. For example, assessing the brightness uniformity of finely illuminated icons requires high-resolution imaging equipment. Additionally, the brightness measurement camera needs to have a resolution that is suitable for working with high-resolution displays. For this reason, we made the decision to provide a new luminance camera system model with a 9 million pixel image sensor resolution. The new Sony CMOS monochromatic image sensor, together with a class A V-lambda correction filter and a precisely chosen lens, forms the foundation of the GL OPTICAM 2.0 4K TEC. Every optical system offered by GL Optic comes with factory calibration, which is a multi-step process that guarantees laboratory accuracy and traceability.

Best-in-class optical system

An optical correction filter that is specifically chosen and calibrated for the image sensor is included with every camera system. In contrast to digital cameras that are mass-produced, GL Optic instruments are made using premium glass filters and lenses from reputable vendors.

The TEC unit enhances stability and expands the dynamic range of the image sensor by thermally stabilizing it.

The system configuration can be automatically changed with the aid of a revolutionary RFID system for automatic lens recognition. With the aid of our GL OPTICAM SOFT analysis software, this light camera brightness meter enables quick setup and measurement of various objects. You may monitor the image, adjust the parameters, and measure the brightness by capturing an image of the device's user test of the luminance scene by simply plugging this calibrated imaging luminance meter into your PC.

The analytical software will immediately display other important data, present brightness levels and histograms, and determine default regions of interest. The technology assists in analyzing particulars and areas and might even offer the required adjustments. Similar to a standard scientific equipment, this one offers absolute luminance accuracy.

When colour matters

The standard GL OPTICAM 2.0 4K TEC luminance meter can be used in conjunction with our GL SPECTIS 1.0 Touch spectral device to allow luminance and color testing and assessment when the lighting fixture or electrical board uses multiple color LEDs. Combining the spectroradiometric measurement with the luminance camera measurements is possible with our GL SPECTROSOFT. Thus, we are able to offer complete colorimetric and spectral data for the LED product that is being tested, as well as the mismatch correction

for brightness values to obtain the maximum accuracy.

GL OPTICAM 2.0 4K TEC Features

Plug and measure with RFID automatic lens recognition*

Digital luminance camera system that is uniquely calibrated and preconfigured for quick testing of light components and quality control of light devices. This instrument is easy to use; just place it in front of the lighting system to measure the absolute brightness level right away. The calibration file is uploaded by the system when it detects the lens automatically. For product testing and field measurements related to lighting system quality control, use this tool in the lab.

Improved optical resolution

This accurate brightness measuring device with 9 pixel resolution can enhance your research and development when creating a new, intricate optical system. You can now decide on modification and/or compliance more quickly.

Thermal stabilisation

To counteract measurement inaccuracies caused by temperature variations, this instrument has a TEC unit for thermal stabilization of the image sensor.

Dedicated V- lambda filter

A carefully chosen class A optically adjusted filter is fitted to every camera to ensure the best possible brightness measurements that match the sensitivity of the human eye. Every filter has a unique optimization for every CMOS sensor.

Adding spectrum and colour

The quality control can be expanded with colorimetric values such as CCT, CRI, and many more by combining this new picture luminance camera with our spectrum instruments, such as GL SPECTIS 1.0 Touch. It will also enable the measurements of multiple-color LED devices and offer an automatic filter mismatch adjustment process.

GL OPTICAM 2.0 4K TEC Metrics

Photometric quantities

- Point Luminance [cd/m²]
- Luminance distribution
- Iso candela diagram
- Average luminance
- Min Max diagram and tables

Spectral color quantities

- Correlated Colour Temperature – CCT and Duv
- Colour Rendering Indices – Ra, CRI, R1 to R14
- New rendering Rf and TM-30
- Colour Uniformity
- Binning and colour consistency
- Spectral Power Distribution

GL OPTICAM 2.0 4K TEC Luminance measuring device for laboratory applications <https://youtu.be/O7DM6kQEDAA>

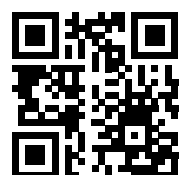

SCAN TO VIEW
VIDEO

GL^{OPTIC} Imaging Luminance System

READY-TO-MEASURE
IMAGING LUMINANCE
MEASUREMENT DEVICE
GL OPTICAM 2.0 4K TEC



**for laboratory
applications**

← [Back to partner](#)



Light Measurement Solutions > Light Meters

GL OPTICAM 1.0

Imaging luminance meter for precise testing

Engineers and designers can better regulate lighting performance with the use of secondary optics and diffusing materials in LED lighting product development. As a result, in order to prevent glare issues, makers of LED-based lamps and luminaires require dependable luminance testing solutions that enable them to confirm brightness uniformity when diffusing materials are utilized and determine the maximum luminance levels.

To maintain uniformity and control over product performance, all touch-screen control panels, displays, backlit keyboards, and signage must be tested during the research and development phase. As the uses for LED lighting products grow, so does the need for on-site luminance measurements. These measurements are needed for maintenance control of both indoor and outdoor lighting installations as well as lighting audits for both new and retrofit LED installations.

The entry-level GL OPTI CAM 1.0 optical camera system offers outstanding performance at a reasonable cost. It has a lens designed for accurate luminance measurements and a high-resolution CMOS image sensor with a V-Lambda correction filter to mimic human reactions to brightness. If you require testing for brightness and color, the extra features can be used in conjunction with our GL SPECTIS 1.0 Touch spectral instrument.



Instant luminance measurement

This high-sensitivity and high-resolution camera system is ready to use in the field, in production, or in the laboratory for instantaneous brightness measurements. With our imaging luminance camera for LEDs and other light sources, you can plug and measure whenever you require quick and accurate luminance testing. Every luminance camera has a $V(\lambda)$ optimized filter installed and is calibrated separately.

Develop better products

You can quickly verify the quality of components while picking out parts for your new product or selecting a new supplier. This will assist you in selecting the appropriate parts and improving the functionality of your product. In the R&D department, utilizing a brightness measuring camera system directly will enhance quality control while saving costs and time. You can make decisions about modification and/or compliance on-site and have more control over your R&D process.

Simplify production testing

For luminance quality monitoring throughout the production process of LED modules, a fast and reliable

optical system is needed. In order to provide dependable and useful data for pass-fail production monitoring systems, this image luminance meter can be integrated into production inline and off-line testers for LED modules, displays, and instrument cluster testing.

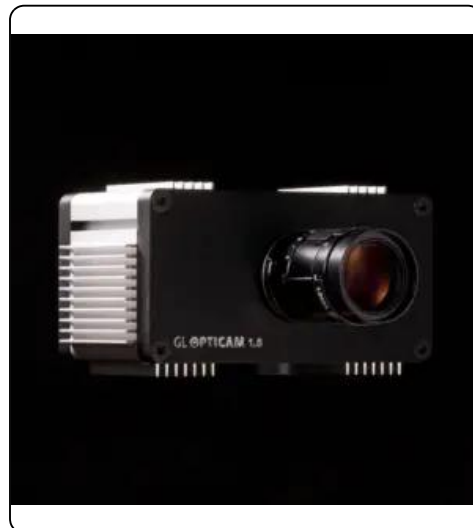
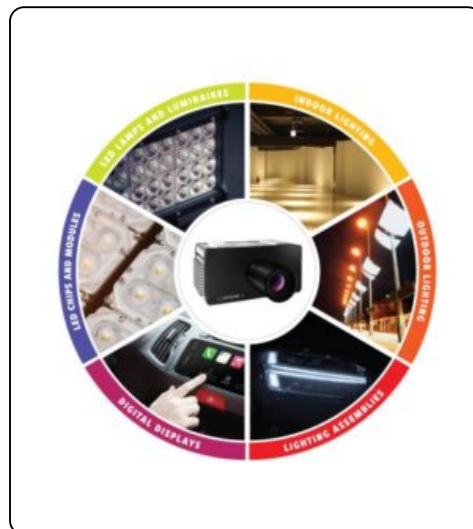
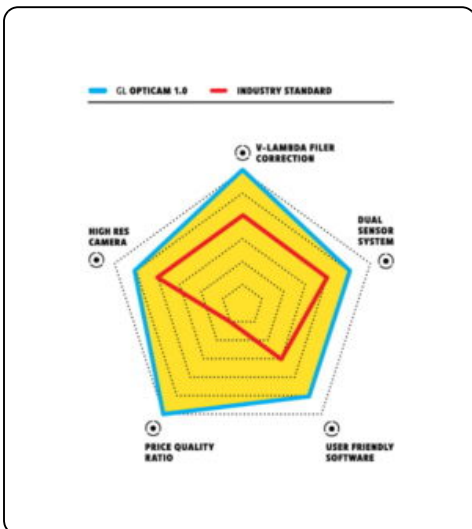
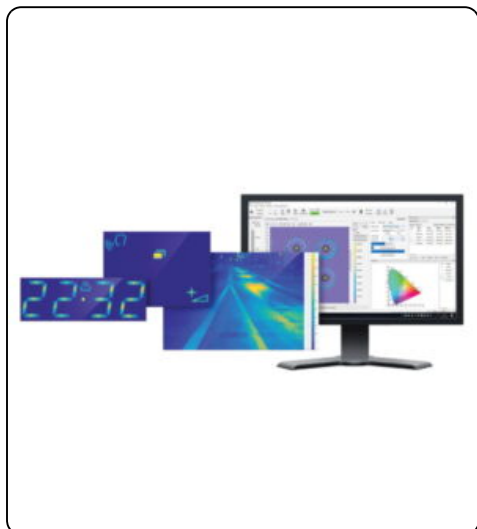

GL OPTICAM 1.0 Usage

Luminance under control

Existing clients in the automotive and home appliance electronics sectors spurred the development of the GL OPTICAM image luminance device. For efficient and trustworthy component testing during inbound QC,

development, and production testing, they needed a camera system that was both easily accessible and dependable. It soon became clear that many additional clients dealing with LED-based lighting goods also needed the same system, which calls for useful and user-friendly equipment for brightness measurements both in-house and on-site. The new Sony CMOS monochromatic image sensor, along with our V-lambda class A correction filter and a carefully chosen lens for multipurpose luminance tests and measurements, served as the foundation for the construction of GL OPTICAM 1.0. This instrument is a useful tool that can be used anywhere while retaining laboratory precision and performance thanks to its small housing design.

Demanding measurements made easy

With the aid of our GL OPTICAM SOFT analysis software, this light camera brightness meter enables quick setup and measurement of various objects. Just connect this calibrated imaging luminance meter to your PC, and you may use it to measure brightness, configure parameters, and monitor image quality by taking a picture of the device. The analytical software will immediately display other important data, present brightness levels and histograms, and determine default regions of interest. The technology assists in analyzing particulars and areas and might even offer the required adjustments. Similar to standard scientific equipment, this one offers absolute luminance accuracy.

When luminance and color matters

The basic GL OPTICAM 1.0 luminance meter can be used in conjunction with our GL SPECTIS 1.0 Touch spectral device to provide luminance and color testing and assessment when the lighting fixture or electrical board uses different color LEDs. Combining the spectroradiometric measurement with the luminance camera measurements is possible with our GL SPECTROSOFT. This allows us to provide complete colorimetric and spectral data for the LED product that is being tested, as well as mismatch correction for brightness values to obtain the best accuracy.

GL OPTICAM 1.0 Features

Plug and measure

Digital luminance camera system that is uniquely calibrated and preconfigured for quick testing of light components and quality control of light devices. Measure the absolute brightness level by positioning this device on the tripod in front of the lighting system. For product testing and field measurements related to lighting system quality control, use this tool in the lab.

Dedicated V- lambda filter

A carefully chosen class A optically adjusted filter is fitted to every camera to ensure the best possible brightness measurements that match the sensitivity of the human eye. Every filter has a unique optimization for every CMOS sensor.

Adding spectrum and color

The quality control can be expanded with colorimetric values such as CCT, CRI, and many more by combining this new picture luminance camera with our spectrum instruments, such as GL SPECTIS 1.0 Touch. It will also enable the measurements of multiple-color LED devices and offer an automatic filter mismatch adjustment process.

GL OPTICAM 1.0 Metrics

Photometric quantities

- Point Luminance [cd/m²]
- Luminance distribution
- Iso candela diagram
- Average luminance
- Min Max diagram and tables

Spectral color quantities*

- Correlated Color Temperature – CCT and Duv
- Color Rendering Indices – Ra, CRI, R1 to R14
- New rendering Rf and TM-30
- Color Uniformity
- Binning and color consistency
- Spectral Power Distribution

[← Back to partner](#)



Light Measurement Solutions > Light Meters

GL PHOTOMETERS

Photometers optimized for different applications

Explore a new selection of high-quality, precise photometric instruments with fast sample rates, high sensitivity, and laboratory-level V-lambda correction for various light measuring applications. A variety of photometer types designed for light measurement have been introduced thanks to the development team at GL Optic's vast experience. Beginning with measurements of illuminance (lx) in a lab setting, moving on to quicker measurements of Luminous Intensity Distribution (LID) during gonio-photometric testing, characterizing light modulation (including flicker), and concluding with dynamic on-site measurements on the roads. Choose the model that works best for your needs.



Faster photometry

Use our newest rapid photometer model, the GL PHOTOMETER 3.0 LS + Flicker, to experience a new level of quality in quick on-the-spot gonio-photometric measurements. When used with the GL Goniometer, this gadget can produce results up to ten times quicker than those obtained using the conventional point-to-point gonio measuring method. When in on-fly mode, this gadget accurately reproduces a luminous intensity curve for each plane by taking many thousands of measurements per second.

Light flicker measurements

Large levels of light flicker can be measured with the high-speed (125 kHz) photometer GL PHOTOMETER 3.0 + Flicker when used in conjunction with the GL OPTI SPHERE System. The most recent essential flicker metrics, such as VESA (Video Electronics Standards Association), JEITA (Japan Electronics and Information Technology Industries Association), SVM (Stroboscopic Visibility Measure), PstML, flicker frequency, flicker index, flicker ratio, SAM, and Mp (flicker perception), are easily obtainable through the PC program GL Spectrosoft.

Dynamic tests of road lighting

This class A luminosity photometer, the GL PHOTOMETER HSLx 2.0 WP, was created specifically for outdoor measurements. Its IP64 casing provides weather and dirt resistance. A "mobile laboratory," comprising three or more pieces of equipment, can be established to facilitate the dynamic measurement of road illuminance in accordance with EN 13201:2015 regulations. This kind of equipment can be mounted on an automobile bumper or paired with a laptop, special software, and a trailer. Coordinate data is added by the GPS system for use with the Google Maps Geocoding API or a comparable service.

Class A photometers

The photometer's spectrum response is exactly the same as the spectral sensitivity of the human eye. This reduces the typical miss-match errors in measurements of various light source types for this sort of equipment. On request, the Class-L version is provided.

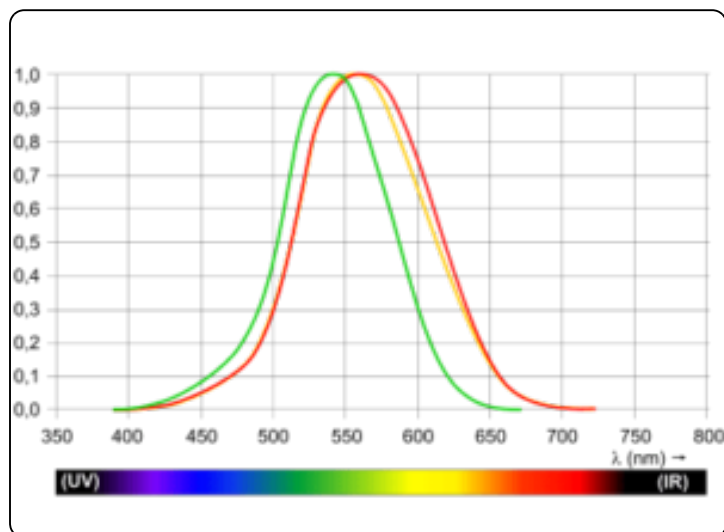

Integrating sphere flicker measurements

The GL spectroradiometer in the integrating sphere measuring system can be supplemented by this rapid photometer. LED light flux and efficacy measurements are made possible by a GL spectroradiometer mounted on an integrating sphere of any diameter. The most recent industry-mandated flicker metrics, including flicker frequency, flicker index, flicker ratio, SVM (Stroboscopic Visibility Measure), PstLM, SAM (Stroboscopic Acceptability Metric), Mp (also known as LRC Flicker Perception), VESA (Video Electronics Standards Association), and JEITA (Japan Electronics and Information Technology Industries Association), are all measured by a GL PHOTOMETER 3.0 + Flicker plugged into the second port of a GL OPTI SPHERE.



Ecodesign directive EU 2019/2020 compliant

Beginning in September 2021, new minimum standards for flicker and the so-called stroboscopic effect will be implemented throughout Europe. Light modulation can be measured with GL PHOTOMETER 3.0 LS + Flicker, and the PC software GL SPECTROSOFT provides the most recent measures, including SVM (Stroboscopic Visibility Measure) and PstLM, as mandated by the current standards. You can comply with the most recent OLED and LED testing regulations in Europe by using this new GL Optic photometer.



GL PHOTOMETER 3.0 + Flicker Usage

2 in 1 high precision illuminance photometer with wide dynamic range & accurate flicker meter

In addition to standard photometry, the high-sensitivity, high-sampling-rate GL PHOTOMETER 3.0 + Flicker photometer can measure light flicker in great detail. Even the most difficult measurement jobs can be completed thanks to features such as a large dynamic range (0,001–10 000 000 lx), spectral response uncertainty ($f1'$) of less than 3% (Class A), and cosine correction ($f2'$) of less than 1.5% (Class A).

Standalone fast photometer

One can utilize the new GL Photometer 3.0 + Flicker as a stand-alone photometer. It is ready for usage in several applications where an accurate measurement of surface illuminance is necessary. GL Spectrosoft offers intuitive control over it, or external software can utilize a specific API. The device is powered by the USB connection; thus, no other power sources or batteries are needed.



GL PHOTOMETER 3.0 LS + Flicker Usage

Enabling goniometer On-fly measurements

A goniometer arm travels from point to point in a measurement grid and stops at each location to take a measurement in a typical goniophotometric measurement. It may take many hours, depending on the measuring grid's selected density. Goniometer arms rotate at a steady speed from one extreme position to

the next as measuring devices scan the light distribution coming in from a rotating DUT during on-fly measurement.

The GL PHOTOMETER 3.0 LS + Flicker accurately reproduces a photometric luminous intensity curve for every plane by taking thousands of measurements every second. You can complete a thorough scan of asymmetric street lighting with varied light distribution in less than half an hour, or you can complete a quick scan of an LED lamp in a matter of minutes. The results are obtained considerably faster.

Class A photometer

The photometer's spectrum response is exactly the same as the spectral sensitivity of the human eye. This removes measuring inaccuracies from various light sources, which are common with this type of meter.



GL PHOTOMETER HSLx 2.0 WP Usage

Waterproof photometer for demanding applications

The Illuminance Photometer Class A, from GL Optic, is specifically made for outdoor measurements. Its IP64 casing provides weather and dirt resistance. In order to establish a mobile laboratory that complies with EN 13201:2015 standards for measuring the illuminance intensity of a moving roadway, three or more GL PHOTOMETERS HSLx 2.0 WP can be utilized. This kind of equipment can be mounted on an automobile bumper or paired with a laptop, special software, and a trailer. In order to enhance the photometric data, a GPS system like this one can be used to retrieve coordinates from the Google Maps Geocoding API or any comparable service.

The spectrum sensitivity of the GL Photometer HSLx 2.0 WP (V-lambda class A, cosine correction class A) is exactly equal to that of the human eye. GL SPECTROSOFT provides straightforward control over it, or external software can utilize a specific API. The device is powered via a USB cable connection, so neither extra power sources nor batteries are needed. It has a universal photographic mount installed.

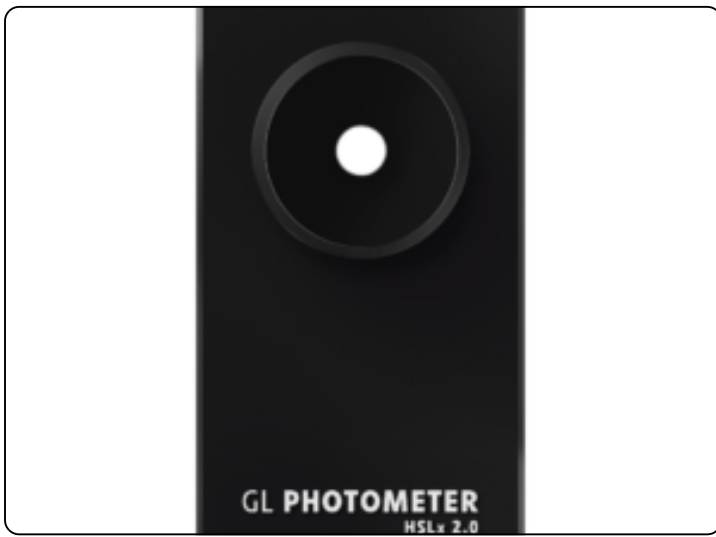

GL PHOTOMETER 3.0 TEC Usage

Class L photometer with thermally stabilized photodiode

A thermally stabilized photodiode powers the class L (DIN 5032-7:2017) photometer GL PHOTOMETER 3.0 TEC. In addition to routine photometry, extensive studies of light flicker are made possible by high sensitivity and a high sampling rate (125 kHz). It is ready to function with a stray light-eliminating tube in goniometric measurements. Optical components that are in charge of cosine correction are not used in this configuration. This device has a direct USB connection to the PC and can be controlled by external software via a specific API, or GL SPECTROSOFT.





GL RETROREFLECTOMETER 4.0 SRS

RETROREFLECTOMETER: to measure the reflective properties and color parameters of the illuminated surface

Manufacturers of reflectors and other reflecting surfaces are required by the CIE 54.2 and EN 12899 standards to test the reflection values and ascertain the color coordinates of the lighted surface.

In order to simulate scenarios when vehicle lights shine, such as road signs, and the reflected light returns to the driver's view, GL RETROREFLECTOMETER 4.0 SRS emits light onto the reflecting surface and gathers information about the reflected light.

A high-sensitivity monochromator is used, which makes the entire measurement incredibly exact and quick—just a few seconds!



Measurements in accordance with requirements of international standards

The design of GL RETROREFLECTOMETER 4.0 SRS complies with CIE 54.2, which specifies acceptable reflectance measurement techniques. With the GL Optic reflectometer, you may conduct tests in compliance with EN 12899 for road sign measuring as well as the ECE R3, ECE R27, ECE R48, and FMVSS 10 standards.

Highest precision and wide measurement range

The reflectometer's A-type halogen illuminator (2856 K) makes it possible to precisely determine color parameters. Another option is to imitate different illuminants.

On the other hand, great sensitivity and consistent, lightning-quick measurement times are ensured by the fast monochromator.

Full information about properties optical reflected radiation

Spectral matching filters have the potential to introduce mistakes and have a detrimental impact on measurement precision. Higher measurement precision is achieved, particularly in the red and blue range, by the GL Optic retroreflectometer's lack of a spectrum matching filter to the sensitivity of the human eye $V(\lambda)$.



GL RETROREFLECTOMETER 4.0 SRS Usage

The GLG A 50-1800 goniometer is the exclusive focus of GL RETROREFLECTOMETER 4.0 SRS. A comprehensive measuring system for vehicle reflectors, warning triangles, road signs, and all varieties of reflective tape is produced by combining these two devices.

Finding the ratio of reflected light to surface illumination intensity (CIL) and the x and y color chromaticity coordinates are the fundamental uses of a retroreflectometer.

Fast monochromator expand possibilities

The rapid monochromator used by the GL Optic device sets it apart from other options. This technique removed the requirement for V (λ) spectral correction filters, which prevent mistakes due to mismatches between the characteristics of the filters and allow photometric parameters to be determined based on measurement for different kinds of illumination.

Using a monochromator enables the examination of variations in the spectral properties of reflecting coatings as well as the extension of the measurement results' range by several parameters derived from the reflected light's spectral distribution.

GL RETROREFLECTOMETER 4.0 SRS Features

Measurements in line with requirements and more

For road sign measurements, items are tested on the H, V, or epsilon axes in compliance with the standards' requirements.

Apart from the standard-required measurement of color chromaticity coordinates (x and y), the GL Optic retroreflectometer may concurrently measure numerous other color characteristics.

Fast and reliable

In the visible range, a single measurement takes only two seconds!

The gadget is shielded from a reduction in measurement accuracy caused by the aging of the light source that illuminates the surface being examined by the implemented age compensation technology.

More possibilities

It is feasible to test parameters for illuminants other than the default illuminant A because of the utilization of the spectral measuring approach.

GL RETROREFLECTOMETER 4.0 SRS Metrics

Our individually calibrated, preconfigured equipment provide quick and accurate results for almost any realistic light measuring application. With the software that comes with it, you can measure in a matter of seconds and examine the data.

Using the GL RETROREFLECTOMETER 4.0 SRS, you can measure any or all of the following optical quantities:

- CIL
 - Chromaticity coordinates x, y
 - CCT c - the color temperature according to standard CIE
 - Duv
 - Full spectral distribution in the visible range
- +many more!**

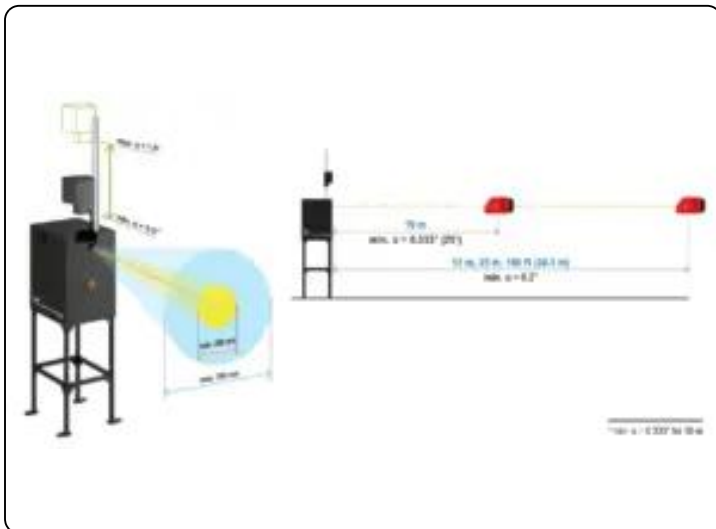

← [Back to partner](#)



Light Measurement Solutions › Light Meters

GL SPECTROLUX

Handheld spectral light meter

Many light meters are simply not capable of providing the fast, accurate measurements needed for LED and other lighting systems. As a pioneer in professional light measurement test instruments, we created the GL SPECTROLUX as a cost-effective, easy-to-use spectrometer accessible to all lighting specialists.

This simplified model is perfect for instant assessment of light level and homogeneity, color temperature and coordinates, spectrum power distribution, LED color rendering, PAR/PPFD and more. It is based on our popular GL SPECTIS 1.0 Touch. Featuring a laboratory-quality measurement head for exceptional precision and repeatability, each device is independently calibrated, traceable to global reference standards and sets new industry standards for both performance and cost.



Simple lighting audits

Use this spectral instrument to measure lighting installations, both new and old, on site and demonstrate that the installation meets the design specifications.

Quality lighting products

Take charge of the caliber of your lighting components and products. Use this tool when purchasing new parts to inspect LEDs, drivers or lenses. Why not demonstrate the benefits of your products to customers or end users by using this device as a sales tool?

Easy evaluation and adjustment

This gadget makes it easy to assess and adjust lighting settings when adjusting stage lighting for accurate CCT/CRI of studio and museum lighting to the correct lux levels. Conveniently, the portable meter has a handy uniformity check function.



GL SPECTROLUX Use

This portable, reasonably priced spectrometer can be used for a variety of tasks, such as assessing lighting installations, providing quick control over LED lighting and fixtures, or even helping application and sales engineers teach consumers the quantifiable benefits of today's lighting systems. to show. Finally, by analyzing the installations and goods of competing companies, it can also be used to gain competitive insights.

Results at the touch of a button

Timeless design and advanced technologies ensure consistently accurate results in seconds. You can make quick and more accurate judgments thanks to the immediate display of all important measurement data on the LED display.

Affordable spectrometer: low price, high performance

Despite being the least expensive instrument offered by GL, it comes with the best cosine-corrected DIN Class B measuring head available as a standard accessory. This enables the best possible measurement of light from the 180° measurement situation using Lambert's law of cosines.

Sustainable Built

The GL SPECTROLUX illuminance meter maintains the high caliber of its components despite its affordable price. These sturdy gadgets are made in Europe and meet field audit requirements. They are unique in their class.

GL SPECTROLUX features

Reliable, accurate and intuitively operated spectral instrument

The affordable GL SPECTROLUX spectral light meter offers accurate and reliable optical performance. Reliable light measurement is no longer limited to professionals or external laboratories. Our individually calibrated, preset light measuring equipment produces accurate, timely findings.

Industry Leading Features:

- Self-contained portable spectrometer
- Dark current compensation
- Measuring head DIN class B
- Photometric and radiometric calibration

Powerful reporting and analysis capabilities

The included GL SPECTROSOFT Connect program enables basic analysis and reporting functions that produce meaningful findings. Upgrade to our industry-leading GL SPECTROSOFT program to accelerate your analysis. This customizable, easy-to-use solution comes with unique features such as lighting audit automation and a spectrum mixer, as well as fully customized reporting choices and extensive analytical capabilities.

GL SPECTROLUX metrics

With the GL SPECTROLUX you can measure:

- LUX: lighting level lux [lx]
- foot candles [fc]
- SPD: Spectral power distribution from 380 to 780 nm
- CRI: color rendering index according to CIE and IES TM30
- CCT: correlated color temperature [K]
- Colour: color coordinates according to CIE 1931
- PAR/PPFD: Calculations of photon flux density and photosynthetically active radiation [μmol]

← Back to partner



Light Measurement Solutions > Light Meters

LUMINANCE / RADIANCE

Optic probes for measuring radiance or irradiance

It is crucial to understand what the client needs to measure, the quantities he must supply, the width of the spectral range he must measure in, and the measuring point diameter he will be comfortable with in order to match the best optical probe to the customer's needs.

For radiometric measurements, GL Optic provides a range of optical probes. Their spectral range, level of cosine correction, and kind of optic fiber are different.

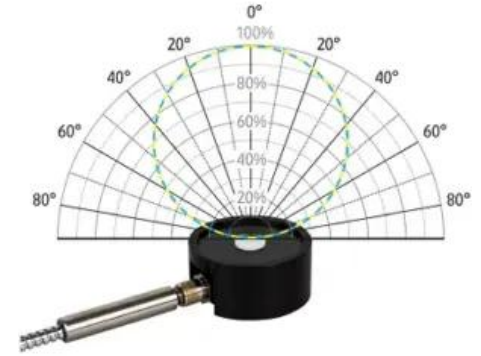

Ready-set-go

Measurement probes, fiber optic cables, and adapters for specialized spectrometers are all included in each full package. includes calibration that can be linked to national labs.

Smart detection

A sophisticated detection system included in every GL Optic Spectrometer recognizes a new probe and installs the relevant calibration file automatically.

Extended spectral range

These optical probes, which are made of high-transmission quartz fiber optics, have a wide spectral range of 200–1050 nm, from UV to NIR.





GL OPTI PROBE 1.0.10 Luminance Usage

The purpose of this accessory is to measure the luminance [cd/m²] of plasma FPDs, flat LCDs, and OLED panels. Television screens, computer monitors, avionics displays, and other electronic displays are frequently examined items. Projection screens, signage, and reflecting surfaces (such as walls and work surfaces) are also frequently measured.

This optical probe detects the light that a specific point on the surface of a comparatively large or extended source emits in a given direction. For measuring distance, the measuring probe can be mounted on a tripod; for measuring contact, it can be mounted directly on a screen using a specific stripe. GL SPECTIS 1.0 or GL SPECTIS 1.0 Touch can be connected via the optic probe. A polymer fiber optic cable is included with the probe. Spectrum that can be used: 400–730 nm.

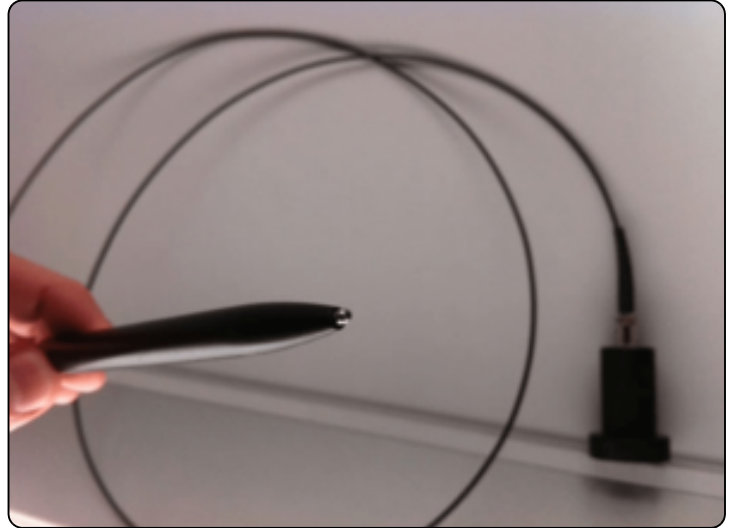

GL OPTI PROBE 1.0.11 Luminance Usage

This optic probe comes with a flexible fiber optic cable and is shaped like a pen with a measuring point diameter of just 1 mm. When small regions need to be measured, it is extremely helpful. GL SPECTIS 1.0 or GL SPECTIS 1.0 Touch can be connected to via the optic probe.

The purpose of this accessory is to measure the luminance [cd/m²] of plasma FPDs, flat LCD and OLED panels. Avionics, other electronic displays, and signal indicators are common devices to be tested. This optical probe detects the light that a specific location on the surface emits in a certain direction. A polymer fiber optic cable is included with the probe. Spectrum that can be used: 400–730 nm.



GL OPTI PROBE 1.0.12 Luminance Usage

An optical fiber-equipped luminance-measuring telescope guarantees an exactly parallel observation beam. Adaptable to a tripod. Spot diameter at 0.5 m distance is 8 mm. Range of spectra: 400–1050 nm. Telescopes that measure luminosity make sure that the observation beam is precisely parallel. For measuring other projection displays, LCD, LED, and OLED panels, as well as flat screens. The kit comes with fiber optics, a measuring probe, and an adapter for GL SPECTIS 1.0 spectrometers that has a coder. Tripods can be equipped with probes.

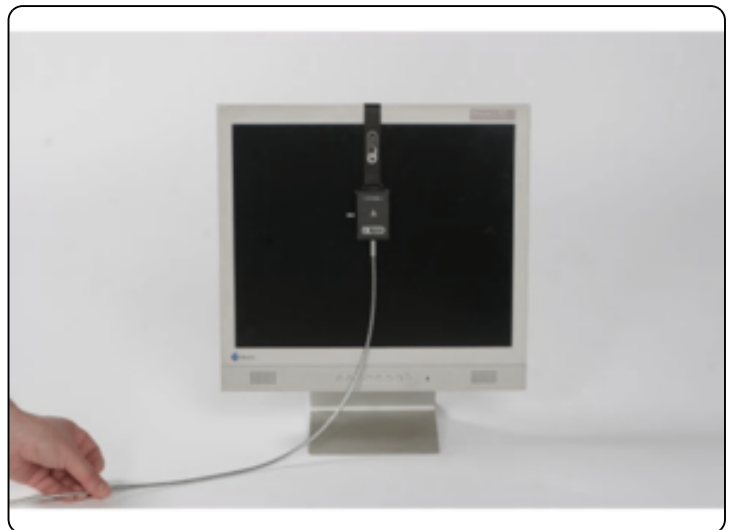
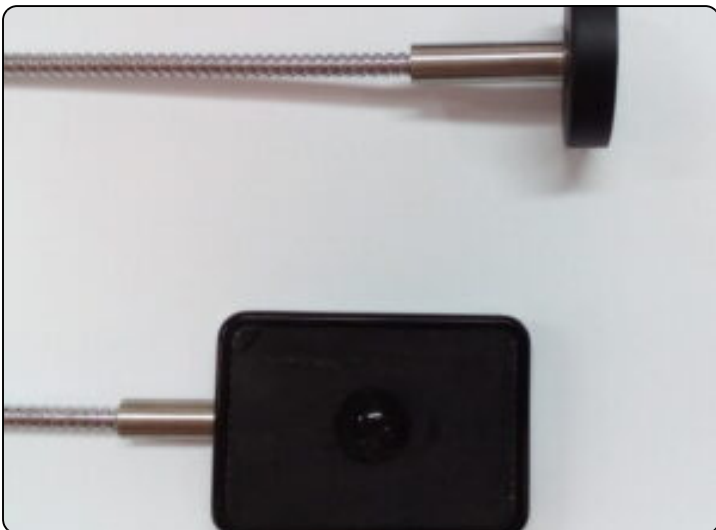

GL OPTI PROBE 5.0.10 Luminance Usage

Luminance probe for point measurement of projection displays, indication lights, LCD, LED, and OLED panels. The kit comes with a counterweight with a strap to hang above the measured screen, quartz fiber optics, an adapter with a coder for the GL SPECTIS 1.0 series spectrometer, and a measuring probe. The probe's frame is prepared to hold a typical photo tripod. Within the range of the utilized spectrometer, this probe covers the entire spectral range, from UV to IR. N.A. is 0.20.



GL OPTI PROBE 5.0.51 Luminance Usage

For point measurement of flat screens, LCDs, LED OLED panels, projection displays, and signaling lights, use a pen-style brightness probe. The kit comes with a quartz fiber optic adapter, a measuring probe, and a coder for spectrometers that are GL SPECTIS 5.0, 6.0, and 8.0 compatible. Within the range of the utilized spectrometer, this probe covers the entire spectral range, from UV to IR. N.A. is 0.20.

← [Back to partner](#)



Light Measurement Solutions > Light Meters

ILLUMINANCE / IRRADIANCE

Probes to measure illuminance or irradiance

The use of specialized probes is necessary for a variety of distinct optical qualities and measuring geometries. As a full-line manufacturer, we provide a range of optical probes with varying spectral ranges, degrees of cosine correction, and types of optic fibers for photometric and radiometric studies. All of our spectrometers come with irradiance and illuminance probes, which are made specifically for each system based on the optical performance and spectral range of the device.

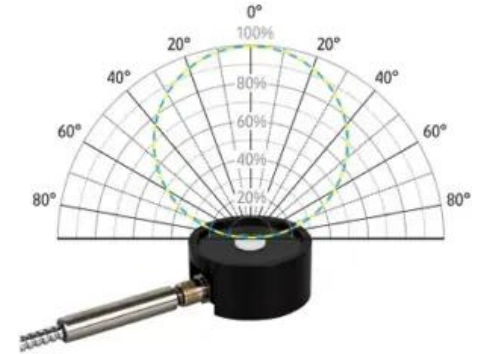

Ready-set-go

Measurement probes, fiber optic cables, and adapters for specialized spectrometers are all included in each full package. includes calibration that can be linked to national labs.

Smart detection

A sophisticated detection system included in every GL Optic Spectrometer recognizes a new probe and installs the relevant calibration file automatically.

Made for everyday use

Excessive performance and precision no longer equate to excessive complexity. Without requiring highly skilled personnel, our solutions produce dependable, repeatable results.

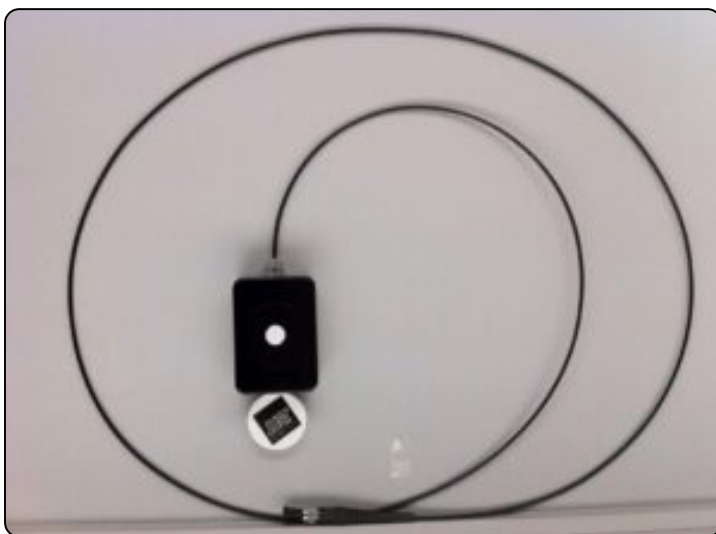



GL OPTI PROBE 1.1.10 Illuminance Usage

Submersible probe for measuring irradiance and brightness underwater. The kit comes with a GL SPECTIS 1.0 series spectrometer adaptor with a coder, polymer fiber optics, and a measuring probe. The only range in which the set can be spectrally calibrated is over 400 nm. N.A. equals 0.22.

The GL OPTI PROBE calculates optical quantities of illuminance [lx] or PAR energy [W/m²], which represent the amount of light flux incident upon a surface per unit area.

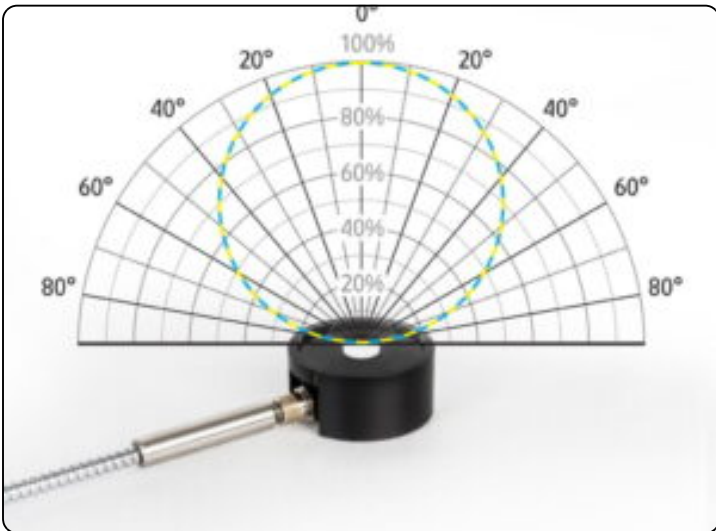

GL OPTI PROBE 5.1.10 Illuminance Usage

For measurements of extended spectral irradiance, an irradiance/illuminance diffuser with quartz glass fiber optics is utilized. The kit comes with a quartz fiber optic adapter, a measuring probe, and a coder for spectrometers in the GL SPECTIS 1.0 series. Within the spectrometer's working range, this probe spans the entire spectral range, from UV to IR. N.A. is 0.20.

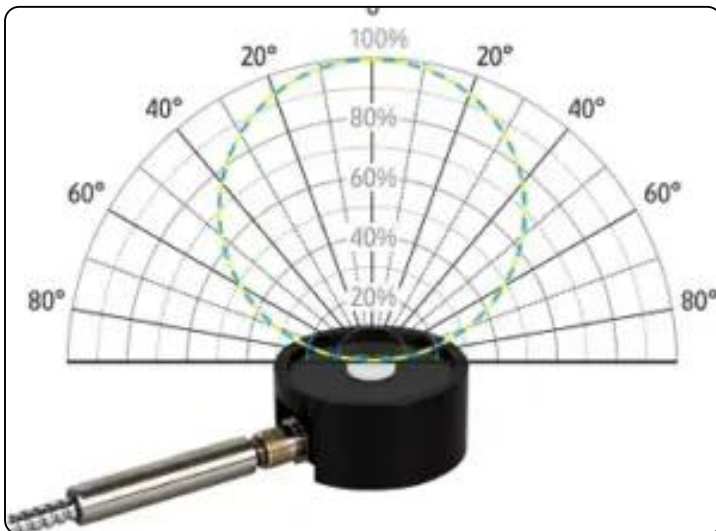

GL OPTI PROBE 5.1.50 Illuminance Usage

For measurements of extended spectral irradiance, an irradiance/illuminance diffuser with quartz glass fiber optics is utilized. The kit comes with a quartz fiber optic adapter, a measuring probe, and a coder for spectrometers that are GL SPECTIS 5.0, 6.0, and 8.0 compatible. Within the limitations of the spectrometer being utilized, this probe spans the entire spectral range, from UV to IR. N.A. is 0.20.

[← Back to partner](#)



Light Measurement Solutions › Light Meters

GL Opticam 1.0

Imaging Luminance Meter for precise testing

This high resolution and high sensitivity camera system is preconfigured for immediate luminance measurements in the laboratory, production or field application. When fast and precise luminance testing is needed, you can simply plug and measure with our imaging luminance camera for LED and other light sources. Each luminance camera is equipped with $V(\lambda)$ optimized filter and individually calibrated.



Simplify production testing

LED module manufacturing requires quick and dependable optical system for luminance quality control. This Imaging Luminance Meter can be integrated into production inline and off line testers for LED modules, displays and instrument cluster testing providing reliable and practical data for pass fail production monitoring systems.

Demanding measurements made easy

The GL opticam, supported by the GL OPTICAM SOFT analytical software, allows the user to set and measure different objects in no time. Simply plug this calibrated imaging luminance meter to your PC, where you can monitor the image and set parameters and measure the luminance simply by recording the image of the device user test of luminance scene. The analytical software will detect default areas of interest, show luminance level, histograms and will immediately display other useful data. The system helps to analyze specific details and regions and even provide necessary corrections. This instrument provides absolute luminance accuracy just like a typical laboratory device.

When luminance and color matters

When the lighting fixture or electronic board is using different color LEDs, the GL Opticam can be combined with the GL Spectis to support luminance, color test and evaluation. The GL Spectrosoft features an option to combine the measurements from the luminance camera with the spectroradiometric measurement. As result you will be able to provide mismatch correction for luminance values to get the highest accuracy and provide all colorimetric and spectral data.



GL OPTI PROBES for radiometric measurements - GL Optic

GL Optic offers a variety of optical probes for radiometric measurements. They differ in spectral range, degree of cosine correction and type of optical fiber.

In order to tailor the best optical probe to the customer's needs, it is important to know what the customer needs to measure, what quantities he needs to deliver, how wide a spectral range he needs to measure and what measuring point diameter he will have. satisfied with.



Features of GL Opti Probes

- supplied in a complete set
- The probe is supplied with a quartz fiber optic cable.
- an extended spectral range
- certificate of absolute spectral calibration
- it communicates with laboratory level GL Spectis 5.0 Touch or GL Spectis 6.0
- made in the European Union Line of optical probes from GL Optic

GL OPTI PROBE 5.0.50 RADIATION

This accessory has a larger spectral range and is intended for measuring luminance or radiation outside the visual range. Typical devices to be tested include: television screens, computer monitors, electronic displays and other electronic displays and where it is necessary to measure reflective surfaces - also paintings, works of art, projection screens and signboards. The optical probe measures the radiation emitted in a given direction from a given spot on the surface of a relatively large or extended source.

For distance measurements, the measuring probe can be mounted on a tripod. Alternatively, it can be placed directly on a surface using a special stripe for contact measurements. The optical probe is connected to GL Spectis 5.0 Touch or GL Spectis 6.0.

The probe is supplied with quartz fiber optic cable. Usable spectral range: 200-1050 nm.

GL OPTI PROBE 5.0.51 RADIATION

This optical probe has a pen shape with a measuring point diameter of only 1 mm and is supplied with a flexible fiber optic cable. It is especially useful when it is necessary to measure small areas. The optical probe is connected to GL Spectis 5.0 Touch or GL Spectis 6.0.

This accessory has an extended spectral range and is intended for measuring the radiance/luminance of flat LCD and OLED panels and plasma FPDs. Typical devices to be tested include: television screens, computer monitors, electronic displays, and other electronic displays. The optical probe

measures the radiation emitted in a given direction from a given spot on the surface of a relatively large or extended source.

The probe is supplied with quartz fiber optic cable. Usable spectral range: 200-1050 nm.

GL OPTI PROBE 5.1.50 INSTALLATION/ILLUMINATION

The probe is intended for measuring irradiation/illuminance. The accessory has an extended spectral range and can be used for photobiological safety assessment in accordance with EN 62471 and EN 14255. This sensor measures the flux received by a surface per unit area.

It is often used in the medical sector (occupational safety and health). The optical probe is connected to GL Spectis 5.0 Touch or GL Spectis 6.0.

The probe is supplied with quartz fiber optic cable. Usable spectral range: 200-1050 nm.

Special optical probes

If you haven't found an optical probe that meets your needs, please contact us (office@gloptic.com). Our R&D center is ready to meet your special requirements!

Each set contains a measuring probe, a fiber optic cable and an adapter for a special spectrometer and a decoder for automatic detection of the corresponding calibration file. It comes with a certificate of absolute factory spectral calibration.

Optic Probes supplied by GL Optic are intended to work with GL Optic spectrometers belonging to the higher range of DIN quality class B. To deliver the highest quality product, GL Optic calibrates each set of spectrometers and optical probes purchased in their European laboratory.



GL OPTI PROBES for photometric measurements - GL Optic

GL Optic offers variety of optical probes for photometric measurements. They differ in spectral range, degree of cosine correction and a type of optic fiber.

To be able to match the best optical probe to customer's needs, it is important to know what the client has to measure, which quantities he needs to deliver, how wide a spectral range he has to measure in and which measuring point diameter he will be satisfied with.



GL Opti Probes features

- delivered in a complete set
- certificate of absolute spectral calibration
- it communicates with GL Spectis 1.0 or GL Spectis 1.0 Touch
- made in the European Union

The line of GL Optic' optical probes:

GL OPTI PROBE 1.0.10 LUMINANCE

This accessory is intended for measuring luminance of flat LCD and OLED panels and plasma FPDs. Typical devices to be tested are: television screens, computer monitors, avionics displays and other electronic displays and where there is a need to measure reflective surfaces – also walls and workplaces, projection screens and signs. This optic probe measures the light emitted in a particular direction by a given spot on the surface of a relatively large or extended source.

The measuring probe can be installed on a tripod for distance measurements. Alternatively, it can be placed directly on a screen with the use of a special stripe for contact measurements. The optic probe connects to GL Spectis 1.0 or GL Spectis 1.0 Touch.

The probe comes with polymer fiber optic cable. Usable spectral range: 400-730 nm.

GL OPTI PROBE 1.0.11 LUMINANCE

This optic probe has a pen shape with just 1 mm measuring point diameter and comes with a flexible fiber optic cable. It is especially useful when it is necessary to measure small areas. The optic probe connects to GL Spectis 1.0 or GL Spectis 1.0 Touch.

This accessory is intended for measuring luminance of flat LCD and OLED panels and plasma FPDs. Typical devices to be tested are: signal indicators, avionics and other electronic displays. This optic probe measures the light emitted in a particular direction by a given spot on the surface.

The probe comes with polymer fiber optic cable. Usable spectral range: 400-730 nm.

GL OPTI PROBE 1.1.10 ILLUMINANCE

The quantities it operates with are illumination or PAR energy . This optic probe measures the amount of luminous flux incident upon a surface per unit area. This optic probe is waterproof and it is designed for special measurements.

This accessory is especially desirable in the horticulture and aquaculture industries. The optic probe connects to GL Spectis 1.0 or GL Spectis 1.0 Touch.

The probe comes with polymer fiber optic cable. Usable spectral range: 400-800 nm.

INTEGRATING SPHERES





Partner **GL Optic**



GL Optic is a Polish-German manufacturer specializing in advanced light measurement systems for photonics and precision optics applications. Their comprehensive portfolio includes spectroradiometers, photometers, integrating spheres, goniometers, and luminance cameras, all designed to deliver accurate and reliable measurements across a broad spectrum of light sources.

Product offering

GL LARGE OPTI SPHERES



GL OPTI SPHERE 1100



GL OPTI SPHERE 500



GL OPTI SPHERE 205



GL OPTI SPHERE 48



GL OPTI LIGHT LED



GL Opti Sphere 1100 - GL Optic



GL Opti Sphere 48 - GL Optic





GL LARGE OPTI SPHERES

Luminous flux of large LED lamps and luminaires

Large integrating sphere sets called GL OPTI SPHERE 1500, 2000, and 3000 are made specifically for measuring the luminous flux, radiant power, and color of large LED luminaires and modules. These systems support testing that complies with LM79 and also meet the recommendations stated in the CIE 127:2007 Technical Report by the CIE Technical Committee.

The sphere's size and the side-opening mechanism make it simple to install a range of light sources with the help of extra adapters or holders, providing complete measuring versatility. This system may be outfitted with any of our high-performance spectrometers along with robust automation and analysis software, just like all of our integrating sphere systems, to provide a fully turnkey system that is simple to use for everyone.



Mount and measure

A mechanical stage that can be modified to accommodate a wide variety of lights and LED module types is included with the GL OPTI SPHERE as standard equipment. It is simple to install various A-type goods thanks to an optional lamp post that is positioned in the center of the sphere. The sphere can be connected to any of our high-performance light spectrometers, and when they are attached to the detector port, the program immediately detects them. Just load the light and leave the rest to the program.

Large LED luminaires

Optimal for combining sphere measurements of big light fixtures, the sphere is offered with various diameters of 1,5 m, 2 m, and 3 m. Utilized across various sectors and adjusted in accordance with national benchmarks, the GL LARGE OPTI SPHERES provides remarkable worth in a market dominated by either inexpensive, subpar equipment or systems that are too expensive for the majority of expanding businesses.

Adaptable to your needs

You can choose the ideal spectral range and features to suit your needs and budget from a variety of light spectrometers and accessories for the GL LARGE OPTI SPHERES. This, along with our robust GL SPECTROSOFT software and GL AUTOMATION add-on, creates a fully functional test station that is simple to operate and allows anyone to get precise, repeatable results.



GL OPTI SPHERE 2000 Usage

Measure, launch, and grow.

An affordable, precise, and user-friendly method for testing and measuring big luminaires during development and as a quality control measure in production is becoming more and more necessary as the number of businesses producing commercial lighting fixtures rises. To fill this demand, the GL OPTI SPHERE 1500, 2000, and 3000 integrating spheres were created, providing a fully turnkey solution for all of your light measurement requirements, no matter how big or little.

Excellent light flux and color accuracy are provided by the GL Optic big integrating sphere without the operational complexity of traditional photometric test equipment. It is not necessary to have a large, dark lab or a dedicated metrologist. In little time at all, set up the system and begin assessing your lighting. The fact that you can simply open the sphere, place the lamp inside, and measure is appreciated by our customers. This sphere has all the parts and accessories you require, and the GL SPECTROSOFT software interface will assist you in doing the task correctly.

A laboratory of your own

For rapid quality control, this equipment works equally well in production labs, accredited laboratory settings, and R&D. For LM79 light measurement applications, the GL LARGE OPTI SPHERE is a great option when using outside labs becomes too costly or time-consuming.

Instant customized reports

Install, measure, and use our GL SPECTROSOFT package to create customized results right away. The measurement tool, an additional light source, and optional peripheral devices like TEC controllers or

programmable and stable power supplies will all be managed by this analytical software. These can all be found in a single comprehensive measurement report.

GL OPTI SPHERE 2000 Features

Specially designed 660 mm entrance aperture

Front-emitting diodes can be measured in 2π geometry at the wall entrance in accordance with CIE standards, whilst other sources of light with broader emission can be measured in 4π geometry at the center of the sphere. A 660 mm entry aperture that was specifically created for the 2 m sphere's entrance can be utilized for calibration. Specific measurement conditions may require the installation of additional gear.

Auxiliary light source

An additional light source has been added to the GL OPTI SPHERE 2000 to offset the self-absorbance of DUTs and achieve optimal measurement accuracy.

GL OPTI SPHERE 2000 Metrics

Integrated quantities

- Total Luminous Flux [lm]
- Radiant power [W/nm]
- Total Photon Flux
- PBAR and more.

Colorimetric quantities

- Correlated Color Temperature: CCT and Duv
- Color Rendering Indices: Ra, CRI, R1 to R15, TM-30
- Fidelity index (Rf)
- MacAdam Ellipses.
- Binning
- Color coordinates

Optional quantities*

- Luminous Efficacy [lm/w]
- Power Factor
- Temperature T_p T_{amb} , etc



GL OPTI SPHERE 1100

Luminous flux of LED modules and luminaires

The GL OPTI SPHERE 1100 integrating sphere system fulfills the recommendations of the CIE Technical Committee, which are published in the CIE 127:2007 Technical Report, and is intended for the measurement of radiant power and luminous flux of large LED modules, mid-size LED luminaires, and other light sources. For expanding LED lighting producers without the room or funds for a 2M or 3M sphere, it is the perfect answer.

This comprehensive and user-friendly integrating sphere system complies with American LM79, CIE S025, and other international standards. With full measuring flexibility that complies with CIE guidelines, the GL OPTI SPHERE 1100 boasts a side-opening design that makes it simple to attach a range of light sources. The GL OPTI SPHERE 1100 can be combined with any of our spectrometers and software tools, just like all other integrating sphere alternatives, to provide the measurement system you require.



Mount and measure

This integrated sphere system has a mechanical stage by default that can be modified to mount a variety of fixtures and LED module types. It is simple to install various A-type goods thanks to an optional lamp post that is positioned in the center of the sphere. The software can automatically identify and connect any of our high-performance spectrometers to the sphere. Just load the light and leave the rest to the program.

Adaptable to your needs

You can choose from a variety of spectrometers and accessories for the GL OPTI SPHERE 1100 to acquire the finest features and spectral range for your needs, both technically and financially. This, along with our robust GL SPECTROSOFT software and GL AUTOMATION add-on, creates a fully functional test station that is simple to operate and allows anyone to get precise, repeatable results.

Accelerate product development

Because of its compact size, this integrating sphere system may be mounted on an office or production floor, giving engineers and R&D teams the ability to test lighting components on-site with speed and accuracy. Long lead times result from sending components and bulbs for laboratory testing, which eventually slows down the development cycle. These days, the findings are accessible right away when fresh boards are manufactured or new fixtures are delivered.



GL OPTI SPHERE 1100 Usage

Measure, launch, and grow.

The market for LED retrofit lamps is growing quickly, and testing and measuring small to medium-sized LED lights needs to be done quickly and with accuracy. Everything from LED modules to tiny strip lights and downlights. To address this demand and provide comprehensive optical assessment of LED retrofit and replacement bulbs, the GL OPTI SPHERE 1100 integrating sphere system was created.

The remarkable luminous flux and color accuracy that the GL OPTI SPHERE 1100 integrating sphere system can provide are possible without the operational complications that come with other photometric test equipment. It is not necessary to have a large, dark lab or a dedicated metrologist. In little time at all, set up the system and begin assessing your lighting. The fact that you can simply open the sphere, place the lamp inside, and measure is appreciated by our customers. This sphere has all the parts and accessories you require, and the GL SPECTROSOFT software interface will assist you in doing the task correctly.

A laboratory of your own

For efficient quality control, this integrating sphere system works well in production labs, authorized laboratory settings, and R&D. When stepping into the world of professional testing and measurement, the GL OPTI SPHERE 1100 is a great starting point—especially when using external labs becomes too costly or time-consuming.

Instant customized reports

Install, measure, and use our GL SPECTROSOFT package to create customized results right away. The measurement tool, an additional light source, and optional peripheral devices like TEC controllers or programmable and stable power supplies will all be managed by this analytical software. These can all be found in a single comprehensive measurement report.

GL OPTI SPHERE 1100 Features

Side-opening system

Complete measuring versatility is made possible by the integrating sphere's size and the side-opening mechanism, which make it simple to insert a range of light sources with the help of extra adapters or holders.

High durability and low weight

Front-emitting diodes can be measured in 2π geometry at the wall entrance in accordance with CIE standards, while other sources of light with broader emission can be measured in 4π geometry at the center of the sphere. The composite material used to make the integrating sphere ensures both low weight and great durability.

Specially designed 168mm entrance aperture

A 168-mm entry aperture that was specifically created for the integrating sphere's entrance can be utilized for calibration. Specific measurement conditions may require the installation of additional gear. The GL OPTI SPHERE 1100 contains an additional light source to counteract the test LED's self-absorption effect and provide optimal measurement accuracy.

GL OPTI SPHERE 1100 Metrics

Integrated quantities

- Total Luminous Flux [lm]
- Radiant power [W/nm]
- Total photon flux
- PBAR and more.

Colorimetric quantities

- Correlated Color Temperature: CCT and Duv
- Color Rendering Indices: Ra, CRI, R1 to R15, TM-30
- Fidelity index (Rf)
- MacAdam ellipses.
- Binning
- Color coordinates

Optional quantities*

- Luminous efficacy [lm/w]
- Power factor
- Temperature T_p T_{amb} , etc



GL OPTI SPHERE 500

Compact integrating sphere system

The GL OPTI SPHERE 500 was created especially for expanding lighting firms operating in the rapidly expanding LED retrofit market, who require a dependable and fast way to test and measure LED modules and medium-sized lights. It is a great option for any manufacturer of LED luminaires who wants to describe the caliber of their product. Instantaneous measurements of luminous flux, color temperature, luminous efficacy, and many other significant light parameters are produced by this 50-cm integrating sphere.



The GL OPTI SPHERE 500 is the ideal countertop instrument because of its compact size, which allows it to provide laboratory precision without requiring a specialized lab or highly qualified personnel. This calibrated system satisfies both American and European requirements for professional LED light measurement instrumentation, as well as CIE global standards. Make an easy-to-use, high-performing sphere spectroradiometer configuration by selecting one of our spectrometer options.

Install and measure

This sphere comes pre-installed with the most widely used lamp holders. The standard lamp post, positioned in the sphere's center, facilitates expert light measurements and product installation. A mechanical breadboard is an optional feature that makes it simple to install various LED lighting fixtures or tiny luminaires.

Accelerate product development

This device is simple to install in a typical office setting, enabling engineers and R&D departments to measure lighting components on-site with speed and accuracy. Long lead times result from sending components and bulbs for laboratory testing, which eventually slows down the development cycle. They can now observe results right away upon the delivery of fresh LEDs or the fabrication of a new board.

Not just for the laboratory

This adaptable sphere system may be quickly and easily customized to fit the demands of individual clients. It can be used as a rapid production control unit or production tester to help measure lights, luminaires, and modules while they are being built. This is used by larger distribution organizations to test purchased products for quality compliance before releasing them into the market.



GL OPTI SPHERE 500 Usage

Your tabletop laboratory

The market for LED retrofit lamps is growing quickly, and testing and measuring small- to medium-sized LED items needs to be done quickly and accurately. This necessity led to the creation of the GL OPTI SPHERE 500 integrating sphere, which provides comprehensive optical assessment of LED retrofit or replacement lights with common sockets like E27, E14, GU10, and others. As we implemented the solution, it became clear that this small benchtop device is suitable for both R&D departments and lighting laboratories for fast component, prototype, and final product evaluation.

Professional light measurement now has an easier access point thanks to the GL OPTI SPHERE 500. It is not necessary to have a large, dark lab or a dedicated metrologist. In no time, set up the system and begin to comprehend your lamps. Even with limited test knowledge, the setup and operation guarantee that the engineering staff produces the correct findings. The fact that you can simply open the sphere, place the lamp inside, and measure is appreciated by our customers. This sphere has all the parts and accessories you require, and the GL SPECTROSOFT software interface will assist you in doing the task correctly.

LED modules, strips, lamps and more

Do you need to measure a lot of different things but lack the funds or room for a big sphere? A great way to get started in the laboratory testing and measuring LED modules, lamps, and other components used in lamp manufacture is using the GL OPTI SPHERE 500. Any of our spectrometers can be used in conjunction with this integrating sphere to provide precise color and flux testing. You may now regulate the impact of new electronic drivers, inspect diffusers and components, and generate reports often and instantly. Obtain photometric data for your prototypes, confirm the LEDs and other parts supplied by your suppliers, and take control of your light quality!

GL OPTI SPHERE 500 Features

Reliable measurement of light

When ordered with the measuring device, all GL Optic spheres are provided with a spectrally calibrated product. Our spheres are compatible with all GL optical spectrometers, making them universally useful. Barium sulfate (BaSO_4) on the interior walls of the sphere ensures high reflectance qualities of up to 97%.

CIE compliant

LED measurement in accordance with CIE 127:2007 and the recently released CIE S 025/E:2015. This sphere also meets all American IES LM and European EN specifications for professional LED light measurement equipment, in addition to other international standards.

Configurable

and 4π measurements of small lamps and modules, use the standard GL OPTI SPHERE 500 system with universal lamp posts and an optional mechanical breadboard. Additionally, every sphere has a side port for precise measurement of 2π sources.

On demand, extra adapters, temperature control mounts, or specialty holders are also offered. Kindly get in touch with us to discuss your needs.

Automated self-absorbance correction

The GL SPECTROSOFT software fully controls the integrated LED auxiliary light source to provide prompt corrections and the best outcomes.

GL OPTI SPHERE 500 Metrics

Integrated Quantities

- Total Luminous Flux [lm]
- Radiant power [W/nm]
- Total Photon Flux
- PBAR and more.

Colorimetric Quantities

- Correlated Color Temperature: CCT and Duv
- Color Rendering Indices: Ra, CRI, R1 to R14, TM-30
- Fidelity index (Rf)
- MacAdam Ellipses.
- Binning
- Color coordinates

Optional Quantities*

- Luminous Efficacy [lm/w]
- Power Factor
- Temperature T_p T_{amb} etc



GL OPTI SPHERE 205

Luminous flux & radiant power measurements of LEDs

An automated, user-friendly substitute for determining the luminous flux and radiant power of LEDs and other small light sources is the GL OPTI SPHERE 205 small integrating sphere. Every measurement complies with the CIE Technical Committee's suggestions, as stated in the CIE 127:2007 Technical Report.

The GL OPTI SPHERE's clever design makes it possible to attach various adapters and measure a variety of light sources. Measurements of front-emitting diodes in 2π geometry at the wall entrance are compliant with CIE standards. It is recommended to test other kinds of LEDs using 4π geometry at the sphere's center. Set up the system according to your application's specifications.



Flexible and expandable

Select from a variety of spectrometers, measure in 2π or 4π , and employ SMA fiber optics or direct connections. These are but a handful of the possible hardware choices. Make even more use of your expertise by utilizing any of our strong software analysis and automation solutions.

Fast and accurate

The GL OPTI SPHERE 205, which is meant to be an everyday tool, is a fantastic substitute for external labs or outdated equipment. On your desk, in your lab, or on the assembly line, get instantaneous laboratory-level color and radiometric accuracy.

Simplicity in design

With just a button push, users of the GL OPTI SPHERE can access all light attributes thanks to its integrated system design. Give up on complicated software and hardware and take charge of your optical development instead.

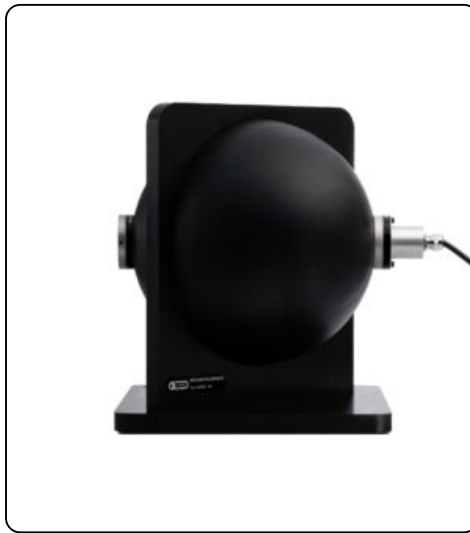
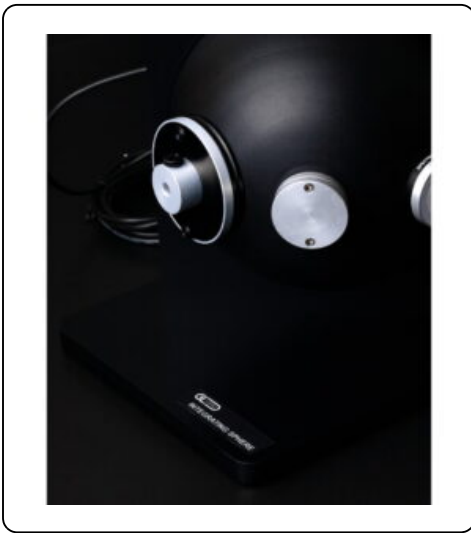

GL OPTI SPHERE 205 Usage

Simplified luminous flux

In order to make light measuring for individual LEDs and small LED modules easier, GL OPTI SPHERE 205 was created. Conventional systems are difficult to operate, frequently sensitive to slight physical changes, and include confusing software that makes it hard to get reliable results without the user's intervention. Peripheral integration makes automated sequences possible, which eliminates this problem.

Reliable measurement of light

Barium sulfate (BaSO₄) on the interior walls of the sphere ensures high reflectance qualities of up to 97%. With the appropriate adapter placed either directly on the sphere or via a SMA fiber-optic cable, any GL SPECTIS series spectrometer can be used with any GL Optic sphere.

GL OPTI SPHERE 205 Features

Precisely designed aperture

The port of the sphere is equipped with a precisely designed 50mm aperture which can be used in partial flux measurements of LEDs. For this application, the test LED is installed outside the sphere at a defined distance and the flux is measured inside the sphere.

CIE compliant

Measurement of LEDs compliant with CIE 127:2007 and new CIE S 025/E:2015. This sphere also complies with other global standards and all American IES LM and European EN requirements for professional LED light measurement instrumentation.

Useful accessories

There are attachments available that are appropriate for certain measuring needs. An additional light source is included in the GL OPTI SPHERE 205 to offset the test LED's self-absorption effect.

Automated self-absorbance correction

The GL SPECTROSOFT software fully controls the integrated LED auxiliary light source to provide prompt corrections and the best outcomes.

GL OPTI SPHERE 205 Metrics

Integrated quantities

- Total luminous flux [lm]
- Radiant power [W/nm]
- Total photon flux
- PBAR and more.

Colorimetric quantities

- Correlated color temperature - CCT and Duv
- Color rendering indices - Ra, CRI, R1 to R14, TM-30
- Fidelity index Rf
- MacAdam ellipses.
- Binning
- Color coordinates

Optional quantities*

- Luminous Efficacy [lm/w]
- Power Factor

← [Back to partner](#)



Light Measurement Solutions › Integrating Spheres

GL OPTI SPHERE 48

Truly accurate flux for single LEDs

The GL OPTI SPHERE 48 is an attachment that integrates spheres with our GL SPECTIS spectrum light meters to measure the luminous flux of small light sources, such as LED chips. An optimal distribution of light and accurate lighting power measurement are made possible by this integrating sphere. Utilize this for LED luminous flux, radiant power, color coordinates, color temperature CCT, and color rendering qualities (CIE CRI; IES TM-30).

This accessory is very easy to use and is a great tool for electronics experts and producers of LED modules in their daily job. When choosing the right parts or needing a fast and precise LED measurement, this is also highly useful for buying managers and agents.



Plug & measure

With the direct mounting of this tiny integrating sphere on the spectrum instrument, the user can obtain precise and instantaneous photometric and radiometric data. Your GL SPECTIS device's measuring capabilities are extended to single LED readings by the spectrum meter's automatic detection of the RFID code.

Lab performance in your hand

By using this device, you may obtain findings that can be traced back to laboratory standards. This allows you to manage the binning (color and flux groups) during the initial selection stage or make more informed decisions about the quality of the LEDs and the items you require for your development. Asking the laboratory to measure these for you is no longer necessary.

Confidence and flexibility

Purchasing various kinds of LEDs or collaborating with multiple vendors? These days, you can quickly and simply examine the color and light output of these parts. Take it a step further and conduct in-depth analysis at every level of development by combining it with the potent GL SPECTROSOFT analysis package.



GL OPTI SPHERE 48 Usage

More than ten years ago, our chief engineer informed our development team, “We need to make a tool that will be easy to use and immediately show accurate results of a single LED,” while they were working on next-generation LED-based lamps for color evaluation. Before we place these LEDs in the prototype module, we need to know the light output and quality. Since then, it has developed into a crucial tool for electronic developers working on LED lighting, who frequently battle with issues like driver selection, LED output optimization, and module and LED output optimization. Rather than choosing the right LEDs for development projects only on the basis of samples and the datasheet, you may use this sphere to rapidly confirm binning, validate performance, and see if samples are meeting specifications. Once your new module has been tested, all you need to do is place the sphere on top of each LED to see how much light it produces. For LED strips, the same applies. For GL optics, utilize our spectral integrating sphere in conjunction with various spectral instruments. See how our PASS/FAIL and GL SPECTROSOFT binning functions can assist you in your business.

GL OPTI SPHERE 48 Features

Apertures for different size LEDs

Don't be fooled by the modest size. Anywhere you need it and for any purpose, this scientific-grade handheld equipment is simple to set up with various apertures to measure light flux correctly. For some situations, a fiber-optic adaptor is also an alternative.

Extended dynamic range

An optional high-signal adaptor, suitable for various luminous flux levels, can be used to measure high-

output LEDs.

Special accessories for QC

Use a remote trigger device that has an indicator bulb to show when a measurement is finished for production or quality control applications. ideal for a trade floor that is noisy. For additional automation, use GL SPECTROSOFT or customer software via the API.

GL OPTI SPHERE 48 Metrics

- Lumen: luminous flux
- CRI: color rendering index according to the CIE
- CCT: the color temperature according to standard CIE
- Color: the chromatic coordinates of the CIE 1931 and CIE 1964
- Fidelity and Gamut: method for evaluating light source color rendition according to TM-30 IES standard
- PAR/PPF: photosynthetic active radiation measurements for horticulture
- mWatt: radiation energy
- **+ many more!**



GL OPTI LIGHT LED

Luminance calibration & reference source

Utilizing JUST LED Technology, the uniform luminance reference light source offers excellent stability and a versatile luminance calibration or verification option. Not only is it feasible to outperform traditional LED sources in terms of light quality, but for the first time, it is also feasible to duplicate an amazing color space with the best quality.

This GL OPTI LIGHT LED can be used as a calibration reference for cameras and other optical instruments, as well as a reference brightness standard in display and monitor calibration systems.

Unparalleled performance

This luminance reference standard is a modular solution that can be readily integrated into production testers or laboratory settings for luminance calibration. It uses the proven, patented JUST LED Technology to ensure great stability over an extended length of time. For excellent uniformity and almost flawless Lambertian diffusion, the system integrates a series of LEDs with an integrating sphere and an exit optic aperture that has been specially constructed. To achieve exceptional color and light output stability and minimal flicker, it has an analog control electronics system and thermal stabilization.

The GL OPTI LIGHT LED 127 CLC is a more sophisticated programmable LED light that comes with closed-loop calibration in addition to the functions mentioned above. This feature ensures longer-lasting light emission stability.



Near-perfect replication of light sources

Ideal uniformity of the source and nearly flawless replication of light sources such as D50, D65, D75, A, and TL 84 are provided by the GL OPTI LIGHT luminance reference. It achieves exceptional colorimetric stabilization through the use of thermal stabilization and an electrical control system.

Choose your interface

Through a USB connection, a PC may operate the device and generate nearly any color source. As an alternative, the device's embedded LED control panel can be used to change the settings. To facilitate seamless interaction with automated or production applications, a DLL library is provided.

Control the properties of LEDs

You can store the spectrum qualities in the electronic controls of the unit and adjust each individual LED light

source using only Normlicht's LED technology.



GL OPTI LIGHT LED Usage

A new class of reference light

Using JUST LED technology, this small, homogeneous light source offers a very versatile and stable luminance reference standard. The GL OPTI LIGHT 127 is a brightness standard that can be used as a calibration reference for cameras and other optical instruments, as well as for display and monitor calibration systems. It is constructed with precisely chosen LEDs and a tiny integrating sphere to provide perfect source homogeneity. To provide exceptional colorimetric stabilization, it also has an electrical control system and thermal stabilization.

For the first time, only Normlicht's LED technology has been able to regulate an LED's characteristics. We have created a sophisticated multilevel calibration process that calibrates every single LED light source and stores the spectrum properties in the electronic controls of the device in order to manage the LED properties to our specifications. This method is distinct and offers quality at a cost that wasn't before possible.

Create any light

The GL OPTI LED 127 can be modified using the built-in LED control panel or by utilizing a USB cable to operate it from a PC. You can adjust the light coordinates using the PC software to suit your preferences. A number of light source standards, including D50, D65, D75, A, and TL84, are also included. Two types of calibration are available for the active multilevel calibration system: permanent online calibration that doesn't require an external metrological instrument for operation, and basic factory calibration. With a frequency of over 100 Hz, the GL OPTI LIGHT LED can effectively regulate its working parameters and alter the light output in a way that is permanently undetectable to human sight.

GL Opti Light LED Features

Setting the lighting coordinates

Using a USB cable, a PC may operate the GL OPTI LIGHT LED. As an alternative, the LED control panel can be used to adjust the settings. You can adjust the light coordinates with the JUST software to suit your preferences. A number of light source standards, including D50, D65, D75, A, and TL84, are also included.

Active multilevel calibration system

Two types of calibration are available for the active multilevel calibration system: permanent online calibration that doesn't require an external metrological instrument for operation, and basic factory calibration.

Self-controlling

The GL OPTI LIGHT LED can efficiently control its operating parameters and change the light output in a way that is permanently imperceptible to human sight at a frequency of more than 100 Hz. Not only is JUST LED technology producing better light than conventional LED sources, but it can now replicate a huge color space with accuracy for the first time.



Light Measurement Solutions › Integrating Spheres

GL Opti Sphere 1100 - GL Optic

The GL OPTI SPHERE 1100 has been designed for the measurement of luminous flux and radiant power of LED luminaires and large LED modules, as well as other light sources compliant with the recommendations of the CIE Technical Committee published in the CIE 127:2007 Technical Report. The size of the sphere and the side-opening system facilitate the easy installation of a variety of light sources using additional adapters or holders, allowing full measurement flexibility. Conforming to CIE recommendations, front emitting diodes can be measured at the wall entrance in 2π geometry while other types of LEDs or other sources with wider emission are measured at the center of the sphere in 4π geometry. The sphere is made of a composite material which guarantees high durability and low weight. The entrance of the sphere is equipped with a specially designed 168mm entrance aperture which can be used for calibration purposes. Additional accessories can be installed as required by specific measurement scenarios. In order to obtain top measurement accuracy, the GL OPTI SPHERE 1100 has been equipped with an auxiliary light source to compensate for the self-absorption effect of the test LED.



GL Opti Sphere 1100 features

- measurement of LEDs compliant with CIE 127:2007 and new CIE S025/E:2015
- universal lamp post
- geometry for front emitting diodes and other sources
- universal ports for SMA fiber optics or direction connection
- auxiliary light source for self-absorption compensation

Technical data

- sphere inside diameter: 1100mm
- entrance aperture diameter: 168mm
- outside dimensions: 1200mm x 1125mm x 1800mm
- spectral range: 300-1700nm
- material (sphere/coating): composite/BaSO₄
- auxiliary light source: white LED
- weight: 60 kg

← [Back to partner](#)



[Light Measurement Solutions](#) › [Integrating Spheres](#)

GL Opti Sphere 48 - GL Optic

The GL OPTI SPHERE 48 is an accessory for our [GL Spectis 1.0](#) for the luminous flux measurement of LEDs and other small light sources. Thanks to its acknowledged characteristics, the integrating sphere helps to achieve ideal light distribution and proper measurement of light power. It is an ideal tool for LED quality control /binning/ where features like color temperature and color coordinates are important. The set includes the sphere in a housing with a coder for automatic detection of the accessory. It is delivered with a certificate of factory absolute spectral calibration.



GL Opti Sphere 48 features

- small-size portable measuring tool
- ideal for binning and quick quality control of LEDs
- ready for work immediately after connection to the GL SPECTIS 1.0
- automatic calibration file download
- high precision of test results
- measurement of LEDs compliant with new CIE S 025/E:2015

CALIBRATION SERVICES





Partner **GL Optic**



GL Optic is a Polish-German manufacturer specializing in advanced light measurement systems for photonics and precision optics applications. Their comprehensive portfolio includes spectroradiometers, photometers, integrating spheres, goniometers, and luminance cameras, all designed to deliver accurate and reliable measurements across a broad spectrum of light sources.

Product offering

GL TEC CONTROL SYSTEM



GL Opti Light LED - GL Optic

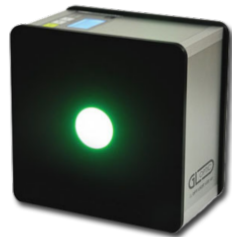



GL TEC CONTROL SYSTEM

Reliable and stable surface temperature control

Stabilized power supplies and consistent, dependable conditions for LED module surface temperatures are mandated by new industry requirements. Because of this, it becomes necessary to simulate different LED operating temperatures or to control and stabilize the temperature of high-power LEDs during the measurements. Lighting designers and manufacturers are compelled by new test standards like CIE S 025/E:2015 to prioritize heat control. A novel approach that ensures comprehensive temperature management and control for LED module measurements is the GL TEC Control System. It is a well-coordinated combination of components that comprises a spectrometer, an integrated sphere, a programmable power supply, and advanced software.



Integrated solution

The lab-grade GL SPECTIS 6.0 spectrometer and the state-of-the-art TEC controller-connected TEC Mount with Peltier element for heating or cooling are part of the turnkey system. Both are then linked to a programmable power supply and an integrating sphere called GL OPTI SPHERE 500, which are managed by Spectrosoft.

High-precision monitoring and control

The module can replicate almost any operational temperature and establish steady measurement conditions. GL AUTOMATION is a potent utility included in the GL SPECTROSOFT software suite that controls heat.

A wide range of luminaires

With a maximum load of more than 30 kg and a maximum diameter dimension of 1800 mm, the GLG 30-1800 will meet the majority of testing requirements. Possess a variety of big and tiny fixtures? Not an issue. With no mechanical adjustments, the device is able to precisely define both large and tiny fixtures.

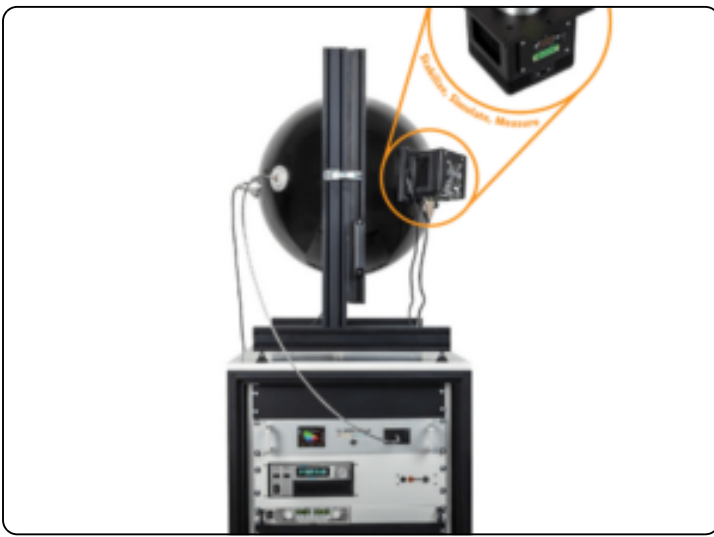

GL TEC Control System Usage

Control your temperature

New LED drivers, LED chips, and lights are tested and developed in development labs using the GL TEC Control System. The module can replicate almost any operating temperature and establish stable measuring circumstances thanks to its high-precision temperature monitoring and control system. GL AUTOMATION is a potent utility included in the GL SPECTROSOFT software suite that controls heat. It is used to organize, execute, and keep track of automated test scenarios, as well as to operate all of the linked instrumentation.

GL-TEC Control System Features

Thermal stabilization of LED modules

- Measurement of luminous flux and color at 25°C
- 85°C junction temperature measurement according to IES LM standards

Simulation of different temperatures

- Any working temperature simulation between 5 and 85°C
- Automatic changes of setting and measurements
- Additional probes for T_p point measurements

*Different sizes and thermal capacity mounts are available.



GL Opti Light LED - GL Optic

GL Optic is presenting its latest development: The uniform light source using the JUST LED Technology providing high stability and flexible solution for the luminance purposes. This GL OPTIC LIGHT LED can be used as a reference luminance standard in the display and monitor calibration systems as well as a calibration reference for cameras and other optical instruments. It is made with the use of the set of LEDs and the integrating sphere providing ideal homogeneity of the source. Additionally it features the electronic control system and thermal stabilization in order to achieve extraordinary colorimetric stabilization.

JUST Normlicht's LED technology has achieved the ability, for the first time, to control the properties of LEDs. To control the LED properties to our requirements we have developed a complex multilevel calibration procedure that calibrates each single LED light source and stores the spectral properties in the unit's electronic controls. This process is unique and therefore has a patent filed for by JUST Normlicht.

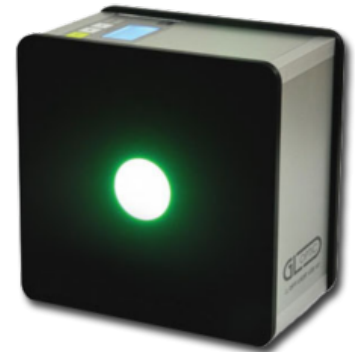

GL Opti Light LED features

- very high uniformity
- near-perfect replication of light sources like D50, D65, D75, A, TL 84
- free selection of light spectra out of color space bigger than sRGB
- stable conditions thanks to a unique calibration method
- much longer lifetime of LEDs thanks to the active thermal stability

Create any light with GL Opti Light LED from GL Optic

The GL OPTI LIGHT LED can be controlled from a PC via USB cable. Alternatively the settings can be made using the LED control panel. The ad JUST software allows you to set the light coordinates according to your needs. It also features several light source standards such as D50, D65, D75, A, TL84. The active multilevel calibration system is divided into the basic factory calibration and permanent online-calibration during operation without using an external metrological device. The GL OPTI LIGHT LED is effectively self-controlling its operating conditions and is adjusting the light result with a very high frequency (>100Hz) permanently and invisibly to the human eye. The JUST LED technology is not only exceeding the conventional LED sources in light quality, but is now for the first time able to replicate a tremendous color space with the highest quality.

Technical data

- spectral range: 385-750nm
- LED color peaks : 390; 450; 470; 520; 590; 633 (+/-10 nm)
- uniformity: +/- 1%

- luminance range: 100-3000 cd/m²
- colorimetric stability: +/- 0.0020
- dimensions: 215mm x 215mm x 130mm

SOFTWARE

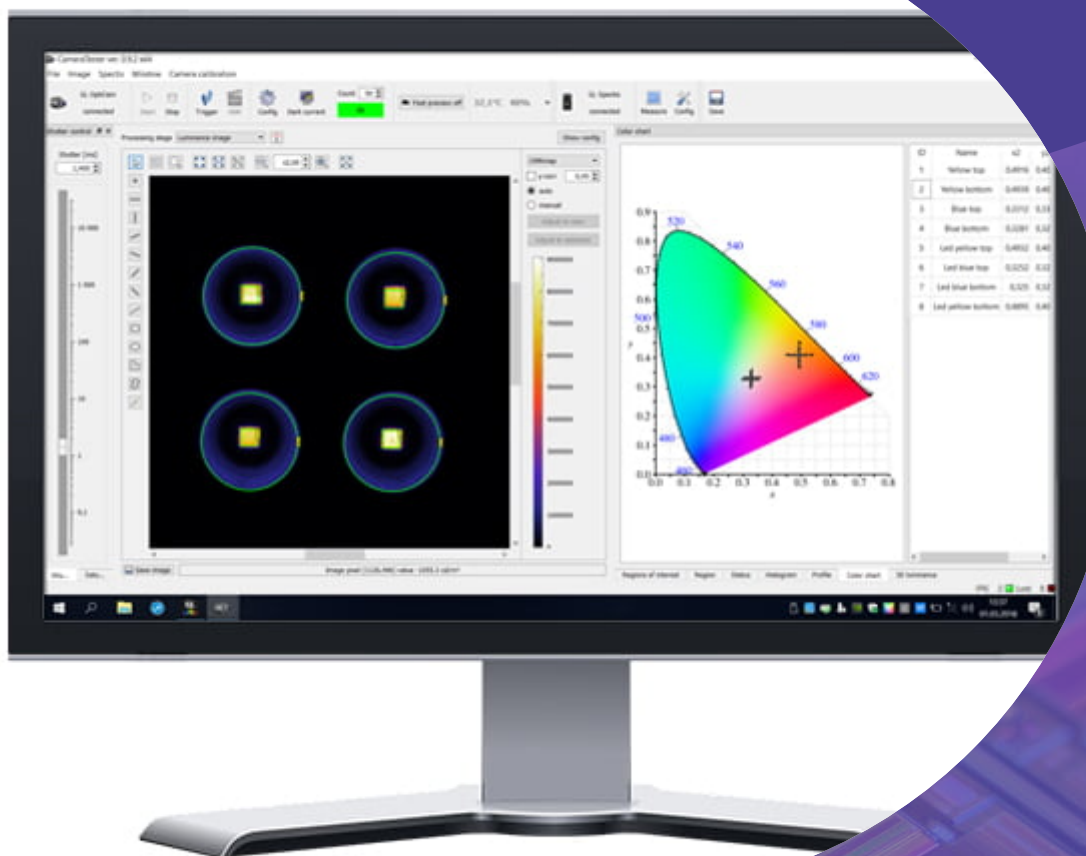



Partner **GL Optic**



GL Optic is a Polish-German manufacturer specializing in advanced light measurement systems for photonics and precision optics applications. Their comprehensive portfolio includes spectroradiometers, photometers, integrating spheres, goniometers, and luminance cameras, all designed to deliver accurate and reliable measurements across a broad spectrum of light sources.

Product offering

GL EPREL PRODUCT REGISTRATION SPECTROSOFT ADD-ON



GL AUTOMATION - SPECTROSOFT ADD-ON



GL SPECTROSOFT M



GL SPECTROSOFT
the brains behind our systems

GL Spectrosoft Automation - GL Optic



GL Spectrosoft - GL Optic

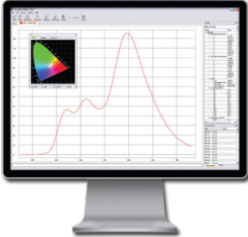

← [Back to partner](#)



Light Measurement Solutions › Software

GL EPREL PRODUCT REGISTRATION SPECTROSOFT ADD-ON

ECODESIGN requirements for lighting

The European Union put certain criteria on lighting product importers and producers in 2019 with the introduction of Directive 2009/125/EC, also referred to as ECODESIGN. These requirements must be fulfilled for items to be sold in the EU. Reducing the number of subpar products available in the EU is the project's primary objective.

A new product needs to be registered in the EPREL database before it can be made available for purchase. A matching energy-efficiency label is created and needs to be prominently displayed for the client and put on the package.



Easier entry of products into the EPREL database

Even after the EPREL database has been up and running for a while, product registration issues persist. The required tests must be completed and the results imported into an.xml file in a format that is rigorously defined in order to register a product. The EPREL database is currently difficult to use and requires a lot of time to enter data.

In response to the demands of lighting producers and importers, we have developed a GL SPECTROSOFT software add-on that expedites the introduction of products for sale. The measurement results will be automatically saved by GL EPREL ADD-ON in the appropriate format and exported to a file that can be imported into the EPREL database. Don't waste time; outfit your lab with the EPREL add-on.

Measurements in accordance with the requirements European standards

The GL SPECTROSOFT software add-on has been designed in compliance with the EU Directive 2019/125/EC criteria. The application saves all data as a suitable report in the.xml format and automatically determines the values of every parameter required to register the product in the EPREL database.

Importing to EPREL is as easy as never before

Thus far, the EPREL database's product registration procedure has necessitated laborious and intricate manual labor. All it takes to create a comprehensive report that is ready for import into the EPREL database is one click with the EPREL Product Registration Add-On. Really, registering your product in the EPREL database will only take a few minutes.

Define, quantify, import, store, and execute.

Compatible with existing GL OPTIC systems

Test stands for GL EPREL Product Registration ADD-ON can be readily modified by laboratories with GL OPTIC measurement equipment to enable completely ECODESIGN-compliant measurements. Assemble the measuring tools your lab needs and take advantage of the opportunities the EPREL ADD-ON add-on presents.

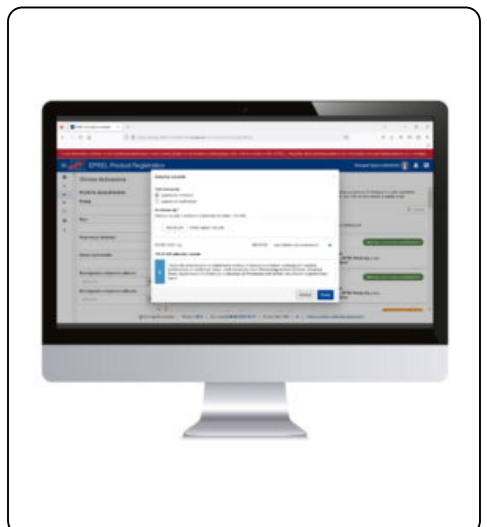
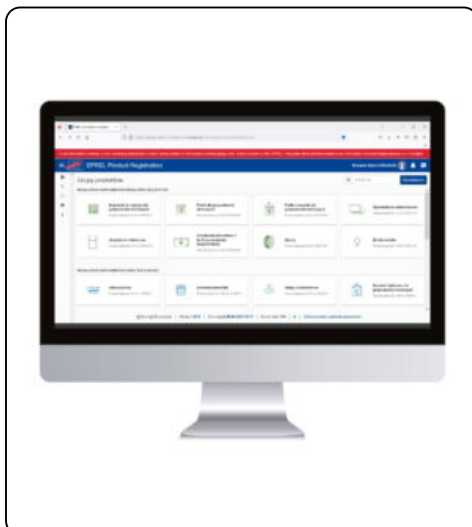
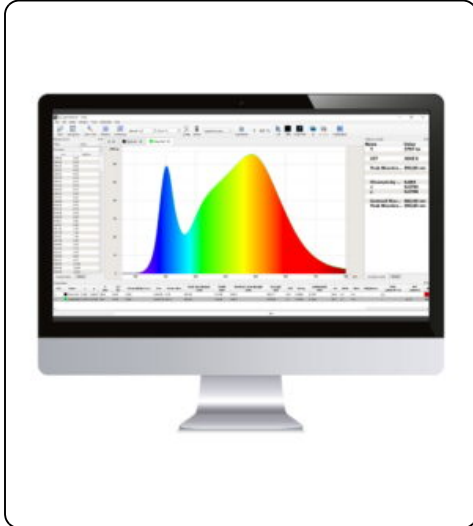

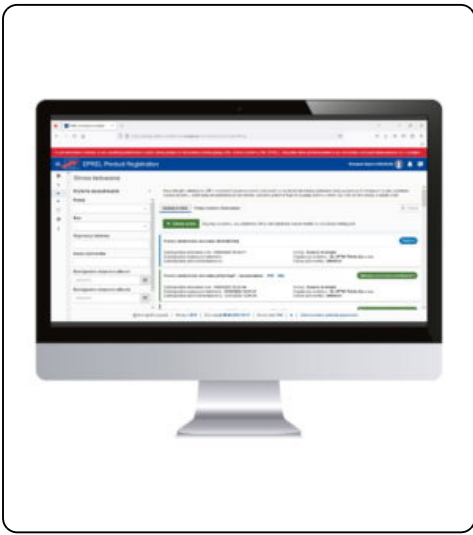

A guide in the process of registering light sources in the EPREL database

The program for the GL EPREL Product Registration Add-On is highly user-friendly. It walks the user through the process of creating a comprehensive report step-by-step and saves the measurement findings as a compressed.zip bundle.

The add-on can be used without the need for specialized knowledge. The entire procedure consists of completing a form with the tested source's technical specifications, which must be entered in compliance with ECODESIGN guidelines. The application makes measurements and does additional computations in order to produce a report that is ready to be saved.

← [Back to partner](#)



Light Measurement Solutions > Software

GL AUTOMATION - SPECTROSOFT ADD-ON

Minimize errors and maximize efficiency

LED light measurement is becoming more diverse than only optical testing; reporting and measurement are now needed for thermal conditions, current, and power levels. The GL Spectrosoft Automation add-on reduces mistakes brought on by misalignment of the equipment, automates complex tasks, and speeds up and supplements measurements of other data (such as temperature, luminous efficacy, etc.).

This revolutionary supplementary software communicates with and runs all linked devices, eliminating the need to set up parameters for each one separately. It is the ideal instrument for both commercial applications and laboratories with intricate procedures.



Set operation sequences

Using programmable peripheral devices, it is simple to setup an entire sequence of operations, including cooling temperature, current, and voltage, before a measurement. Select the appropriate measurement options from the available operations list and write a measurement script that the software will run automatically.

Data fusion

Gather information from other sources and compile all of your important data into a measurement report. Just specify parameters, determine whether temperature or current have an impact on how well your lighting product works, and produce a thorough analysis summary.

Automate complex operations

Temperature controllers, multimeters, current sources, and programmable power supplies are all supported by the GL AUTOMATION add-on. The automation script editor can now be used to monitor and measure various current levels or temperature conditions. To have your own device's custom integrations developed, choose from a list of supported devices.



GL AUTOMATION add-on Usage

Other factors that have a big impact on LED performance are given a lot of attention in the most recent industry standards and guidelines for accurate LED measuring. These are mostly used to monitor electrical properties like voltage and current, as well as thermal performance. For this reason, in addition to temperature and stable, monitored power parameters, current LED testing now incorporates optical measurements. Spectrosoft Automation was designed with the express purpose of managing these intricate testing processes and facilitating communication with various instruments, all while offering the operator a single interface and report interface.

Write your script and go

Building a custom measurement script only requires using the drag-and-drop interface and choosing the logical sequence from the list of available commands in the automation editor window once all of the devices that are supported by the automation software have been connected. These scripts could configure your lamp's power supply's beginning parameters, your spectrometer's measurement parameters, and readings from an independent power meter, among other things.

Change the current and test

You can use various current levels and test the optical output of your lighting goods under various circumstances while conducting performance tests and measurements. Your measurement sequence will be built with the software's assistance, and all data will be stored in easily navigable, personalized reports.

Simulate different temperatures

Automation is compatible with Peltier-controlled LED mounts (TEC), which are needed by CIE standards and are capable of stabilizing the LED module at a specific temperature, such as 25 °C. Additionally, it can replicate greater "working" temperatures, which are necessary for LED module tests and measurements according to IES LM requirements. It's as easy as entering the parameters and steps list into the editor. This PC interface allows you to control, switch, and measure a variety of parameters without the need to be a programmer.

GL AUTOMATION add-on Specifications

Devices supported by GL AUTOMATION add-on

Temperature Control

- Arroyo TEC Source controllers.

Tested with Arroyo 5300-08-24 8A / 24V TEC Source

Digital thermometer

- Digital thermometers for GL Opti Sphere

Power meter

- Gossen MetraHit Energy multimeter

GL Sphere Controller

- GL Optic Sphere controller box.

Power supply

- HEIDEN ACS AC power supply
- ITECH IT6333b DC power supply
- ITECH IT7321 AC power supply
- IT7322 AC power supply
- IT7324 AC power supply
- IT7326 AC power supply
- Manson SDP is a simple DC power supply
- Manson SSP is a simple DC power supply
- TDK Lambda DC power supply family, including TDK Lambda Genesys, TDK Lambda Z+, and TDK Lambda ZUP

Note: Integration of new devices is available upon request.

[← Back to partner](#)



Light Measurement Solutions > Software

GL SPECTROSOFT M

Upgradable software for quick & reliable spectral analysis

A modular PC-based analysis program called GL SPECTROSOFT M is intended for use in field operations, laboratories, production quality control, and general light assessment. GL SPECTROSOFT M gives your GL SpecTROMETER more strength, speed, and efficiency with a variety of potent add-ons. Whether comparing lighting settings, reviewing field measurements, or assisting with production quality control, this adaptable software platform offers instant access to all pertinent data.

Powerful light assessment software

GL SPECTROSOFT M, specifically designed light measuring software for GL Optic's measurement device, is "the key" to all of the spectrometers' advanced features. It transforms unprocessed device data into insightful knowledge. The program presents data in both graphical charts that are simple to understand and well-presented, customisable windows (tables). To make the presentation and sharing of data easier, advanced capabilities include structured reporting formats and adjustable pass/fail criteria. All systems come with Spectrosoft Connect; other versions are optional.



Every metric

Parameters like CCT, chromaticity error, peak wavelength, dominant wavelength, CRI, color coordinate values in accordance with CIE standards, ISO, metamerism index, PAR, PPF, PPF, photobiological safety, binning, MacAdam ellipses, and many more should be calculated, assessed, presented, or reported.

Expanded capabilities

The days of exporting data to Excel and using it for data crunching are over thanks to a wide selection of analysis, automation, and reporting applications. The features, which include color mixing, pass/fail, relative comparisons, and more, go beyond "standard" spectrum analysis. Even better, it interacts with CAD to make field audits easier.

Stay up-to-date

Even though the best-in-class analysis and automation capabilities of the GL SPECTROSOFT M light measuring software are already provided, we continue to add new features and tools on a regular basis. We provide the measurements and resources lighting professionals require while also adapting to the ever-changing market.

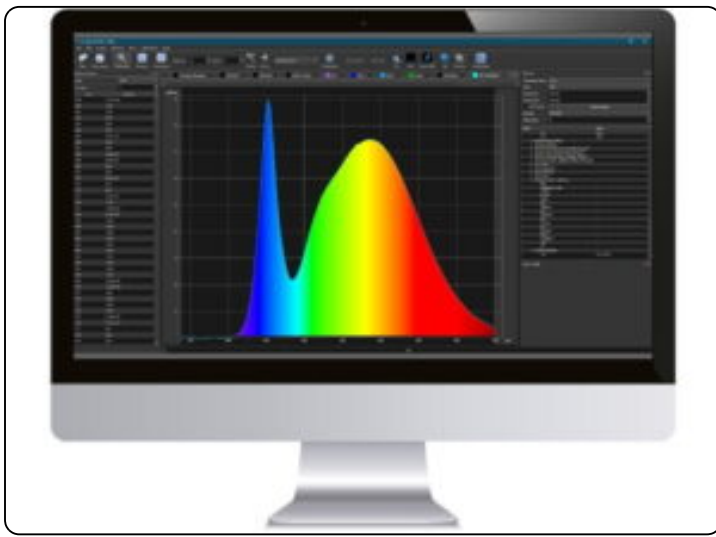

GL SPECTROSOFT M Usage

Multi-purpose

Parameters like CCT, chromaticity error, peak wavelength, dominant wavelength, CRI, color coordinate values in accordance with CIE standards, ISO, Metamerism Index, PAR, PPF, PPF, photobiological safety, binning, MacAdam ellipses, and much more can be computed, evaluated, presented, or reported using GL SPECTROSOFT M.

Experiments

With the help of this light measurement software, a user can experiment with the data they have collected. They can test the data (PAS/FAIL, for example), analyze it using CIE, ISO, and other international standards, compare it to other data (reference window), and perform calculations using various parameters (e.g., counting luminous intensity values).

One platform, all devices

With GL SPECTROSOFT M, integrating sphere or goniometer systems is as simple as plugging in and using any of our spectrometers. Our products are made to grow with your company and do away with the needless learning curves that come with switching software.

GL SPECTROSOFT M Features

OS behind our spectrometers, optical spheres and probes

The user can be confident that the program is displaying absolute values because GL SPECTROSOFT consistently uses the appropriate calibration file for the instruments (the software detects a unique coded

system held in the measurement adapters) (e.g., the measurement made with the sets GL SPECTIS 1.0 and GL OPTI SPHERE shows values of luminous flux in lumens).

Flexible

Our robust light measurement software has a great deal of configurable options that can be tailored to the needs of the customer. For example, you can build your own report template, choose from a variety of parameters that are always available in the quick window “selected results,” or customize the layout to suit your needs.

Data storage

Every measurement value is kept on file and is always accessible for comparison with fresh measurements. To share files with your team or clients, save them locally in our file format or export them to Word or Excel.

Constantly improving

The LED market and its standards are always evolving, so why shouldn't the equipment you use? We continue to make significant investments in our development and uphold strong ties with the standards and market committees in order to provide our clients with comprehensive light measuring solutions.

GL SPECTROSOFT M Calculations

Spectral and color

- New color rendering metrics: IES TM-30-15 and new CIE 224:2017 Color Fidelity Index Rf
- Human-centric lighting evaluation metrics: EML (Equivalent Melanopic Lux) and M/P Ratio (Melanopic Photopic Ratio)
- Colorimetric values: xy chromaticity, peak wavelength, dominant wavelength, purity, color rendering, correlated color temperature, CRI index, MacAdam Ellipses and Metamerism Index.
- Photosynthetic active radiation PAR 400–700 [μmol], PPF [$\mu\text{mol/s}$], PPFD [$\mu\text{mol/m}^2/\text{s}$] and PBAR 350–800 nm
- Photobiological safety includes risk groups assessment wizard and detailed values, including irradiance EB, EBK, ES, EUVA, EUV, EIR Eskin and effective radiance values like LB, LIRA and LVISIRA.
- Radiometric values: irradiance [$\text{W/m}^2 \text{ nm}$], radiance [$\text{W/cm}^2 \text{ sr nm}$], radiant power [W/nm] and radiant intensity [W/sr nm]
- Photometric values: luminance [cd/m^2], illuminance [lux], luminous intensity [cd] and luminous flux [lm]

And optical flicker metrics like:

- Flicker frequency,
- Flicker index
- Flicker ratio
- SVM (Stroboscopic Visibility Measure)
- Flicker graph and FFT graphs are available

Plus many more! Contact us for a full list of calculations.

← [Back to partner](#)



Light Measurement Solutions > Software

GL Spectrosoft Automation - GL Optic

GL SPECTROSOFT AUTOMATION it is new software and an intelligent tool which communicates with and manages peripheral devices.

Instead of the need for setting up parameters in each plugged in device separately, this smart additional software cooperates with and runs all of them. Thanks to this, in one program on your computer, you can set sequences of operations such as: cooling temperature, current and voltage before a measurement. GL SPECTROSOFT AUTOMATION can collect data from external devices and link them together with measurement results.



GL SPECTROSOFT AUTOMATION automates complex operations, supplements and accelerates measurements of additional information (eg. the luminous efficacy, temperature, etc.) and minimizes errors caused by misalignment of the equipment. It is a novelty on the market and a revolutionary solution in light measurement.

This is perfect tool for laboratories, where there is the need for complex operations. The AUTOMATION supports programmable: power supplies, current sources, multimeters and temperature controllers. Automation software can communicate with peripheral devices using a custom-made plug-in.

GL SPECTROSOFT AUTOMATION features

- an intelligent tool which communicates with and manages peripheral devices
- absolute or relative measurements
- you can set up many values such as: temperature, current and voltage before a measurement
- a novelty on the market



Light Measurement Solutions > Software

GL Spectrosoft - GL Optic

GL Spectrosoft is well conceived, intelligent software written for GL Optic's measurement instruments. The software is "the key" for all the advanced features of the spectrometers. It turns raw data from devices into powerful information. The software provides data in well presented and described windows (tables) and also in an easy to interpret graphical schematic view.

Depending on the purchased license level (Basic, PRO or Lab) GL Spectrosoft can calculate, evaluate, present or report such parameters as: CCT, chromaticity error, peak wavelength, dominant wavelength, CRI, color coordinate values according to CIE standards, ISO, Metamerism Index, PAR, PPF, PPFD, photobiological safety, binning, MacAdam ellipses and much more.

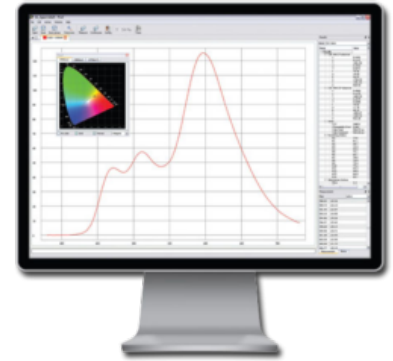

The software gives a user the opportunity to experiment using collected data: to test them (e.g. PAS/FAIL), to analyse them according to international standards (CIE, ISO etc.), compare them with other data (reference window) and make calculations using different parameters (e.g. counting luminous intensity values).

GL Spectrosoft calculates:

- radiometric values: irradiance , radiance , radiant power and radiant intensity
- photometric values: luminance , illuminance , luminous intensity and luminous flux
- colorimetric values: cxy chromacity, peak wavelength, dominant wavelength, purity, color rendering, collerated color temperature, CRI index and Metamerism Index.
- photosynthetic active radiation 400-700 , PPF and PPFD
- photobiological safety

GL Spectrosoft features

- measurement of LEDs compliant with CIE 127:2007
- absolute or relative measurements
- flexible data interpretation
- helpful tools for easy analysis and interpretation of measured spectra

GL Spectrosoft is a smart tool, which operates with all GL Optic spectrometers, optical spheres and probes. The program always uses the right calibration file for the instruments (the software recognises a special coded system held in the measurement adapters) so the user is always sure that the program is showing absolute values (e.g. The measurement made with the set GL Spectis 1.0 and GL Opti Sphere, shows values of luminous flux in lumens) GL Spectrosoft could be configured and adapted to client needs (e.g. you can choose some parameters always available in quick window "selected results", you can built your own template of reports or create your own layout according to the customer's needs). The system stores all the measurement data which can be used in the future

for comparison with new measurements values. GL Spectrosoft is always developing and our support team constantly adds new features. The program works with operating systems such as Windows (also Windows 10) and Mac.

Contact one of our product specialists.